

Metal shelving Meccanocar line "Taurus"



ESEMPIO DI SCAFFALATURA MONTATA ED ALLESTITA

- Metal shelving, equipped with small parts for mounting, robust, versatile, allows you to maximize space in any work environment.
- Painting green RAL 6029 gloss.
- Metal shelving in line Taurus supplied assembled, comprising:
 - 2 modules based art. 4700003325-2525 (A).
 - 1 module mat varied art. 470 00 0335-2527 (B).
 - 1 module p. chemical aerosol art. 00 470 03340-2528 (C).
 - 1 module c / drawers art. 470 00 03370-2534 (D).
 - 1 module for silicone cartridges art. 00 470 03345-2529 (G).
 - 1 module for small boxes art. 00 470 03330-2526 (F).
 - 1 module to a plan art. 00 470 03360-2532 (E).
 - Assembled Size: l1220mm x x p350mm h1680mm.

Code	Desc.
4700003320	2524

Base Module



- With galvanized hardware for mounting.

Code	Desc.	Dimensions mm
4700003325	2525	L610xP350xH180

Module for hardware box



- With galvanized hardware for mounting.
- Movable dividers.

Code	Desc.	Dimensions <i>mm</i>
4700003330	2526	L610xP350xH500

Module for all kinds of material shot with slatted



- With galvanized hardware for mounting.

Code	Desc.	Dimensions <i>mm</i>
4700003335	2527	L610xP350xH500

Module chemical (aerosol) - 70mm widths partitions



- With galvanized hardware for mounting.

Code	Desc.	Dimensions <i>mm</i>
4700003340	2528	L610xP350xH500

Module cartridge type sealants - dividers width. 50 mm



- With galvanized hardware for mounting.

Code	Desc.	Dimensions <i>mm</i>
4700003345	2529	L610xP350xH500

Module for electric cable reels with the insertion of Article. 357 B4 00200 to 14001



- With galvanized hardware for mounting.

Code	Desc.	Dimensions <i>mm</i>
4700003355	2531	L610xP350xH500

10

Module 1 plan



- With galvanized hardware for mounting.

Code	Desc.	Dimensions <i>mm</i>
4700003360	2532	L610xP350xH500

Caisse 4 Drawer Tool

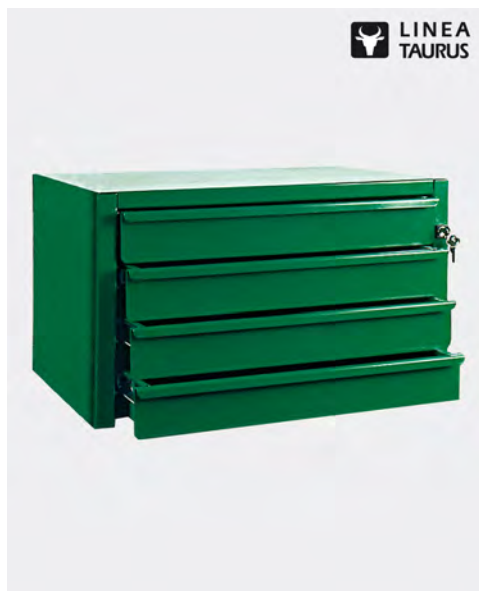

- With centralized closing.
- Drawer height: 55 mm.
- Drawer cm 30x39 mm

Code	Desc.	Dimensions <i>mm</i>
4700003365	2533	L485xP345xH280

Module 4 drawer tool box



- The module consists of the module to a plane over a chest of 4 drawers - joined together.
- With galvanized hardware for mounting.

Code	Desc.	Dimensions <i>mm</i>
4700003370	2534	L610xP350xH500

Magnetic label holders



- Precut magnetic label holders.
- Addressed to all types of customers
- Suitable to label in a simple and rapid shelving, cabinets and any type of metallic container.
- Allow the application and the immediate replacement of bar codes, writings and codes relating to products in the warehouse.
- The label holders are made of soft magnetic rubber with profile magnetized from one side, which allows an effective fastening system, preventing any damage to the surfaces and facilitating the operations of application and replacement of the fingers.
- Possibility of applying the double-sided tape (cod 4060700400-4060700050-4060700100-4060700120) for fixing the magnet to the supports non-metallic.
- Provided of white card on which customize the labels, and a transparent PVC protective and dust.

Code	Desc.	Measures L x H mm
4700007100	360	120 X 20
4700007105	365	120 X 25
4700007110	370	120 X 30
4700007120	380	120 X 40

Drawers assembled door hardware model Madia



- System consists of removable trays tilt opening.
- Suitable for those who want to order and efficiency in the workplace (workshops, coachwork, shops, etc ..).
- The system includes accessories for the creation of wall shelves and floor with stops to prevent unintentional opening of the drawers.
- Drawers, available in different sizes, are realized in transparent plastic materials unbreakable tabs team for product classification.
- A complete storage system by 60 cm.
- Example of the structure, several other possibilities exist.

10

Cupboard 9 drawers



- Drawer dimensions: l 56, p 43, h 64/47 mm.

Code	Description	Length total mm	P	H
3980004400	M1-9 drawers	600	96	112

Cupboard 6 drawers



- Drawer dimensions: l 88, p 65, h 98/70 mm.

Code	Description	Length total mm	P	H
3980004405	M2-6 drawers			

Cupboard 5 drawers



- Drawer dimensions: l 108, p 98, h 148/107 mm.

Code	Description	Length total mm	P	H
3980004410	M3-5 drawers	600	140	168

Cupboard 4 drawers



- Drawer dimensions: l 138, p 127 h 190/134 mm.

Code	Description	Length total mm	P	H
3980004415	M4-4 drawers	600	178	206

Cupboard 3 drawers



- Drawer dimensions: l 180, p 145 h 220/161 mm.

Code	Description	Length total mm	P	H
3980004420	M5-3 drawers	600	210	242

Latches for cupboard



- Material: metal.

Code	Desc.	Tipologia
3980004430	FM1	Freeze for kneading trough 9 drawers
3980004435	FM2	Arrêt pour cupboard 6 tiroirs
3980004440	FM3	Arrêt pour cupboard 5 tiroirs
3980004445	FM4	Arrêt pour cupboard 4 tiroirs
3980004450	FM5	Arrêt pour cupboard 3 tiroirs

Guides for hanging cupboards



- Practical and sturdy frame for wall mounting.
- Made of welded sheet metal and oven-painted with epoxy powder.
- It equipped with 4 holes on the back for convenient wall mounting.
- It provided no cupboards.

Code	Desc.	LxHxP mm
3980004460	MP125	600 x 1000 x 40

Exhibitor with base cupboards



- Practical and sturdy frame exhibitor base.
- Made of welded sheet metal and oven-painted with epoxy powder.
- It delivered dismantled, with screws provided for assembly.
- It provided no cupboards.

Code	Desc.	Dimensions mm
3980004470	MP195	L 600 xP x H 325 1950 (1850 usable space)

Casket for bands and various small parts



- Plastic.
- Container with limit switch.
- With 12 containers and carrying handle.

Code	Desc.	Dimensions mm
3980001500	198	355x460x170

Small part holder



- Small part holder with movable dividers
- Supplied with dividers
- Dimensions mm 400x305x62h

Code	Description
3980004740	4515- Case with movable dividers
3980001910	ABH6-Spare dividers

Polypropylene container assortments - empty case for removable compartments



- Unbreakable polypropylene container.
- For removable compartments.
- Transparent cover.
- The special lid hinge guaranteed not dump parts, even of very small dimensions in phase transport the briefcase.

Code	Desc.	Dimensions mm
3980001900	ABH4	H 57xL 340xP 265

Containers assortments Polypropylene transparent removable

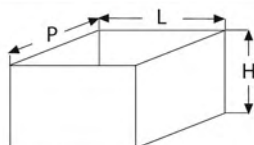

Code	Desc.	Dimensions mm	Filling % bag
3980002000	A 78	H 45xL 80xP 110	1/8
3980002100	A 816	H 45xL 80xP 55	1/16
3980002200	A 916	H 45xL 40xP 110	1/16
3980002300	A 932	H 45xL 40xP 55	1/32

Cases for assortments with 12 or 18 fixed compartments



- Unbreakable polypropylene container.
- Fixed compartments, transparent lids.

Code	Desc.	Dimensions mm
3980001700	200	H 32xL 175xP 145
3980001800	201	H 42xL 240xP 195

Impact polystyrene tray

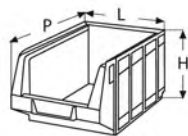

- Polystyrene green.
- Maxime resistance to oils and greases
- Dual system of vertical side follow suit.

Code	Desc.	Dimensions <i>mm</i>
4000000100	2 K	L 108xP 167xH 75
4000000200	3 K	L 151xP 237xH 126
4000000300	4 K	L 213xP 350xH 164
4000000400	5 K	L 310xP 490xH 190

Perforated panel keychain

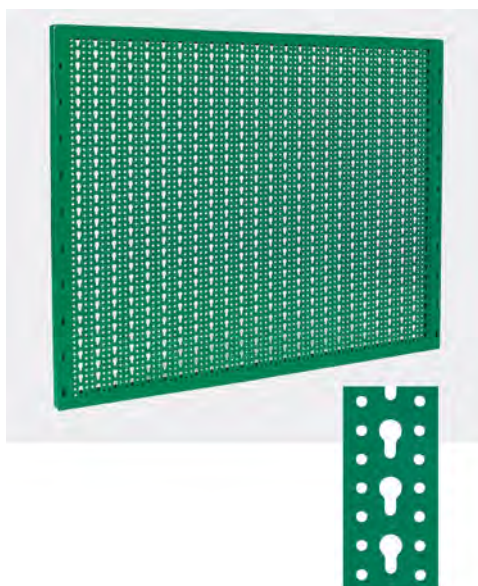

- Double drilling system.
- Hooks for engagement with a slot.
- Painted sheet metal.
- Green RAL 6029 gloss.
- To see hooks n / s Article 443-442.

Code	Desc.	Dimensions <i>mm</i>
4430039600	441	1000x800
4430039610	441-2	2000x800

Ganci portachiavi per pannelli forati



Code	Desc.	Characteristics
4430039700	442-1	STRAIGHT
4430039710	442-2	CURVED
4430039720	442-3	CLAMP
4430039730	442-4	STRAIGHT SHORT
4430039765	442-6	AT HOLE
4430039770	442-7	AT GLASS
4430039775	442-8	AT PAN

Key clip for perforated panels

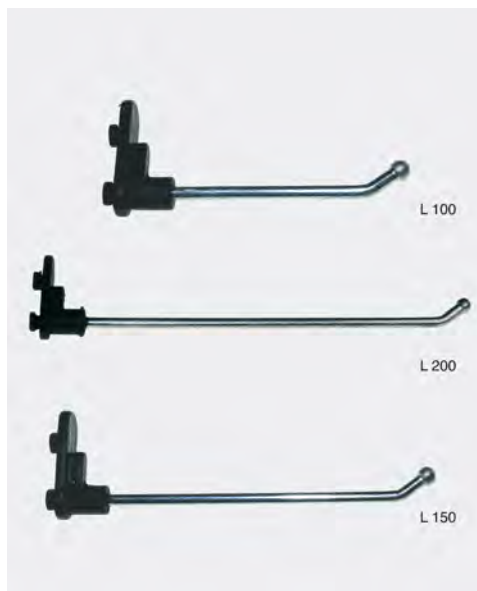

- Hooks with attachment slots.
- ABS support.

Code	Desc.	Characteristics
4430039740	442-5-L10	STRAIGHT L 100
4430039750	442-5-L15	STRAIGHT L 150
4430039760	442-5-L20	STRAIGHT L 200

Kit plastic hooks for panels



- Hook Kits mount slotted

Code	Desc.	N. Pieces
4430039780	442 KIT	50

Contenuto kit

CODICE	DESCRIZIONE	Q.tà
443 00 39700	DIRITTO	N° 10
443 00 39710	CURVO	N° 10
443 00 39720	A PINZA	N° 10
443 00 39730	DIRITTO CORTO	N° 10
443 00 39765	A OCCHIELLO	N° 10

Pegboard keychain



- Perforated plate (4 holes \varnothing) wheelbase mm22.
- With removable shelf.
- Color: Grey.
- To see our art hooks 443-432.

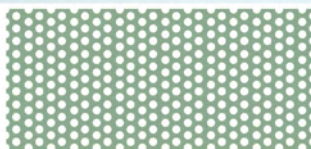

Code	Desc.	Dimensions mm
4430038500	431	1000x850

10

Single hook for perforated panels



- For our panel coloré gray.
- Hooks made of galvanized steel.
- 22 mm wheelbase.

Code	Description	Length mm
4430038600	432-5	60
4430038700	432-10	120
4430038900	432-0 - WITH RING	-

Metal storage shelf for small parts



- Painted sheet, color gray.
- Dividers made of galvanized sheet.
- Cardboard labels.

Code	Desc.	Boxes	Dimensions mm
4430039200	435	36	600x600x12
4430039300	436	114	600x1800x12

Safe Lock Meccanocar I Canvas to entry gates



- Safety lock for gates.
- Made entirely of tempered steel.
- It equipped with patented safety lock with drill protection and anti-bumping.
- Nickel-plating treatment to ensure the corrosion resistance.
- Piston locking protected.
- Piston locking fracture calibrated.
- Cut resistant.
- Easy to use.
- Easy to install.
- Complete with two steel brackets to be welded to the two perforated gate leaves.
- Supplied several pieces with the same key.
- Supplied with three copies of keys.

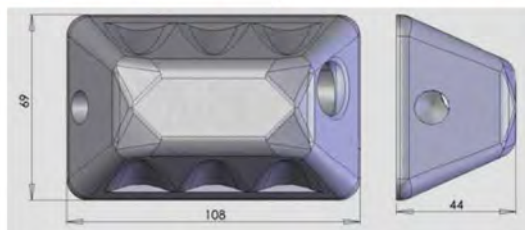

Code	Desc.
4700008000	90-01

Meccanocar Lock Safe II Canvas for shutters



- Security lock for rolling.
- The safest system for closing intrusion of your shutter.
- Lock made entirely of tempered steel.
- It equipped with patented safety lock with drill protection and anti-bumping.
- Nickel-plating treatment to ensure the corrosion resistance.
- Piston locking protected.
- Piston locking fracture calibrated.
- Cut resistant.
- Easy to use.
- Easy to install.
- It comes with two removable head nuts for fixing and related caps to seal the installation holes.
- Supplied several pieces with the same key.
- Supplied with three keys and corresponding card to any requests for copies.
- We recommend the use of two threaded rods M12 length. 200/250 mm.per fixing.

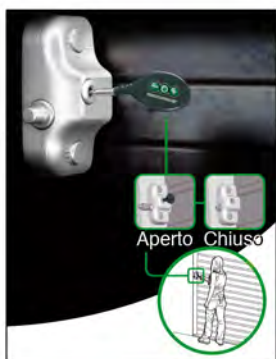
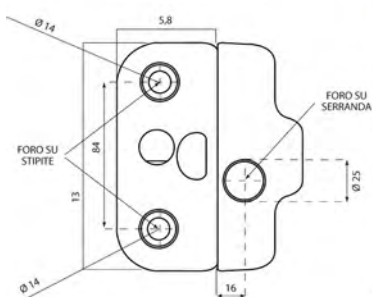

Code	Desc.
4700008010	90-02

Lock Meccanocar Van safety device for commercial vehicles loading location



- Safety device for all types of commercial vehicles, usable both on rear doors that on those side-down.
- Useful to all those who have the need to protect the contents of your van es. electricians, plumbers, couriers, vans roadside assistance etc ..
- Corazza tempered steel with chemical nickel coating which ensures the corrosion resistance.
- Possibility of use with two locking functions, manual or automatic.
- It is sold individually and twice with the same key.
- Supplied with three keys and corresponding card to any requests for copies.

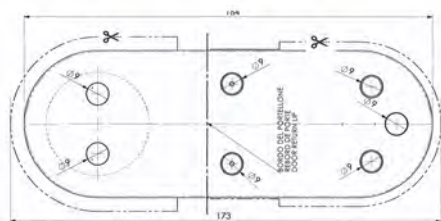

Code	Description
4700008020	90-03
4700008030	90-04 (Double)

Security locks block arc

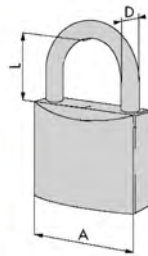

- Security padlock brass cylinder block.
- Arco in hardened steel and chrome.
- Standard equipment: two keys.

Code	Desc.	D mm	A mm	L mm
4700003640	2552/5	5	30	17
4700003645	2552/6	6	40	23
4700003650	2552/8	8	50	27,5

Padlock security steel

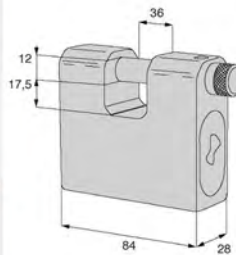

- Armored padlock security rectangular with ball locking.
- Piece body in hardened steel with anticorrosive treatment of chemical nickel.
- Hardened steel shackle with anti-cut chemical nickel treatment.
- Protective plates per cylinder and cylinder, both in hardened steel midsole.
- Standard equipment: two keys.

Code	Desc.
4700003665	2554C

Cart under machine



- Tubular and painted sheet cushion.
- 4 Wheel \varnothing 40.
- Dimensions: alt. 100 mm - lung. 950 mm - larg. 435 mm.

Code	Desc.
3920000200	107

Trolley tour



- Trolley anti-oil rubber. Supporting structure in tube \varnothing 25x1,5 mm.
- 6 rotating wheels \varnothing 50mm.
- Length 980 mm.
- Width 440 mm.
- Height 90 mm.
- Kg Weight with wheels. 9.

Code	Desc.	Characteristics
3920000400	110	CART
3920000500	111	SPARE WHEEL

Tool trays applicable to Cart



- Polypropylene tub shockproof supplied as an accessory.
- Length 300 mm.
- Width 185 mm.
- 40 mm deep.
- Weight 215 grams.
- On the trolley can be mounted up No. 2 pans.

Code	Desc.	Characteristics
3920000600	112	BOWL

Carpets protection



- New carpets in plastzote
- Green Colour
- New material resistant to oils and fats
- Practical Rugs suitable for those who prefer models with wheels
- Extremely lightweight and strong
- Practical to transport
- Large carpet only 500 gr
- Small carpet only 200 gr

Code	Description	Measures (mm)
3920000700	113-large protection mat	995x495
3920000800	114-small protective mat	550x245



Established 1 meter workshop



- Machining plane bench with galvanized sheet metal.
- Thickness: 3mm plan galvanized sheet metal, 1.5 mm structure.
- With bottom shelf and amounts tole painted in green colors ral6029 brilliant.
- Supplied disassembled.
- Weight: 42 kg.
- Range: 1000 kg.

Code	Desc.
4700007700	805-1MT

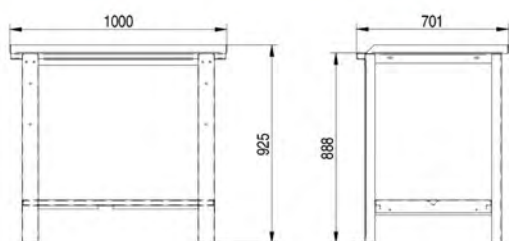

Established Workshop 2 meters



- Machining plane bench with galvanized sheet metal.
- Thickness: 3mm plan galvanized sheet metal, 1.5 mm structure.
- With bottom shelf and amounts tole painted in green colors ral6029 brilliant.
- Weight 76 kg.
- Range: 2000 kg

Code	Desc.
4700007710	806-2MT

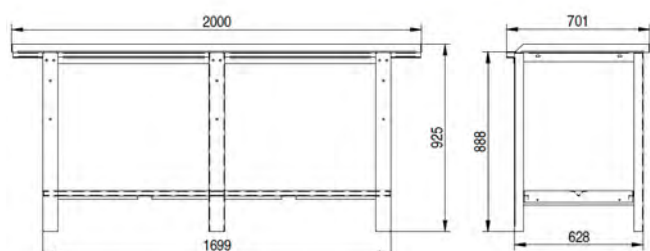

1 drawer for our machining benches and 2 meters



- Drawer guides.
- In tole painted in bright green colors ral6029.
- Weight: kg12.
- Drawer dimensions: 470x470 mm inside hauteur147 mm.

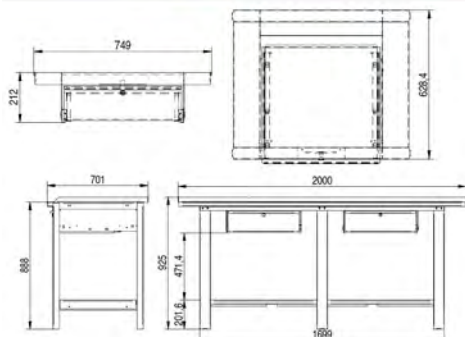

Code	Description
4700007720	807-DRAWER

Perforated panels complete with mounting brackets to our workbenches

- Dimensions: length 980mm x 460mm height.
- Green RAL 6029 gloss.

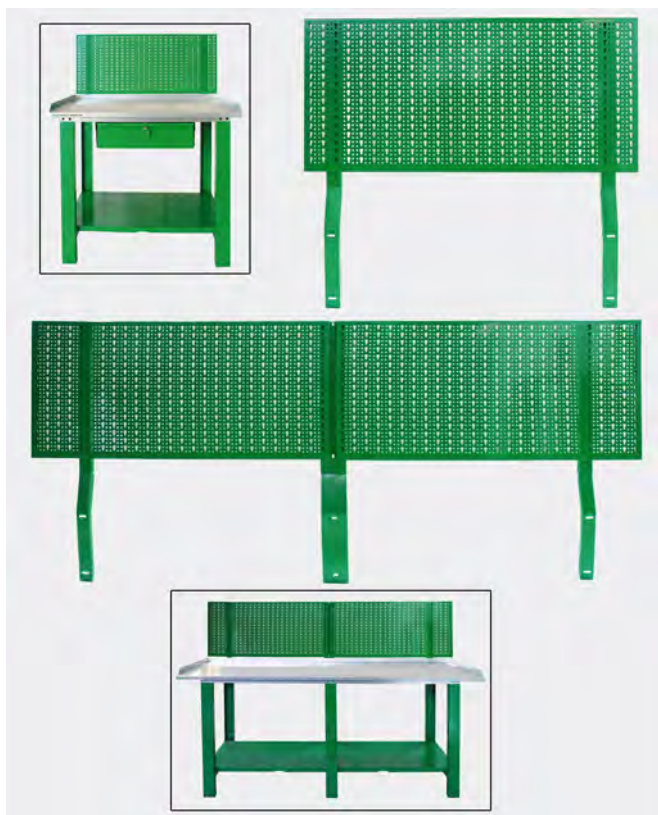

Code	Description	Measure	Attaching
4700007730	808 X 1MT BENCH	980X460	with 2 brackets
4700007740	809 X 2 MT BENCH	2X980X460	with 3 brackets

Wardrobe toolholders



- Painted sheet metal cabinet in the color green ral 6029 shiny.
- With 2 doors and gray ral 7011 internal drawer.
- Perforated panels also introduced on 2 wickets.
- Load capacity: 27 kg.
- Dimensions: length 655mm x 800mm high x 310mm deep.

Code	Desc.
4700007665	804

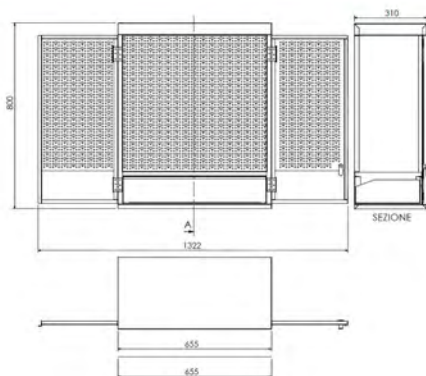

Steel vise



- Parallel vise entirely forged steel C43.
- Double adjustable prismatic guide.
- Serrated jaws induction hardened and ground.
- Hardness: HRC 45/48.

Code	Desc.	Clamp width mm	Jaw opening mm	Jaws slide height mm	Weight Kg.
4430034450	391 - 100	100	130	60	7
4430034470	391 - 125	125	150	70	12
4430034500	391 - 150	150	180	80	19

Covers magnetic jaws

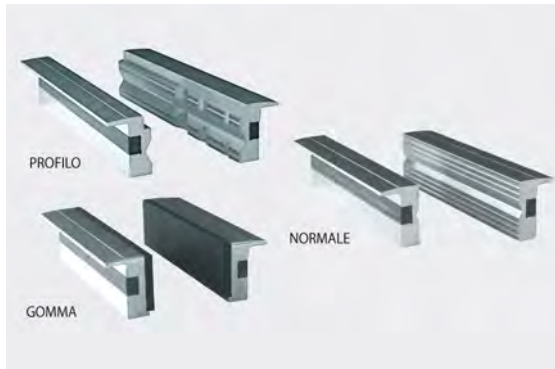

- Magnetic Cover jaw pair for all types of vices.
- With aluminum support.

Code	Desc.	For clamps with jaws	Finishing
4430034510	391G - 100	80 A 105	GUM
4430034515	391G - 125	110 A 125	GUM
4430034520	391G - 150	130 A 150	GUM
4430034530	391N - 100	80 A 105	NORMAL
4430034535	391N - 125	110 A 125	NORMAL
4430034540	391N - 150	130 A 150	NORMAL
4430034550	391P - 100	80 A 105	PROFILES
4430034555	391P - 125	110 A 125	PROFILES
4430034560	391P - 150	130 A 150	PROFILES