

Standard blade fuses

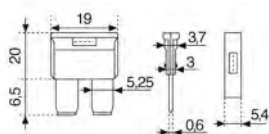

Code	Descriz. <i>corr. nom. (In)</i>	Body color
3520100010	1 A	BLACK
3520100020	2 A	GREY
3520100100	3 A	GREY
3520100150	4 A	PINK
3520100200	5 A	BEIGE
3520100300	7.5 A	BROWN
3520100400	10 A	RED
3520100500	15 A	BLUE
3520100600	20 A	YELLOW
3520100700	25 A	NEUTRAL
3520100800	30 A	GREEN
3520100840	40 A	ORANGE

Standard Fuses blade with Led



- In accordance with the general rules SAE J 1284
- They have an LED that lights up following the fuser interruption
- Self-extinguishing
- Dimensions as standard UNI

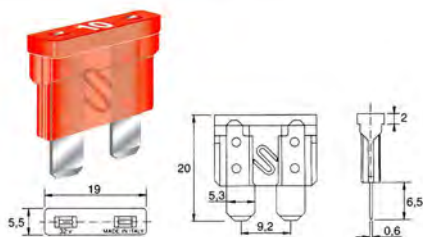

Code	Descriz. <i>corr. nom. (In)</i>	Body color
3520102710	3A fusibile lama Uni con led	VIOLET
3520102715	5A fusibile lama Uni con led	BEIGE
3520102720	7,5A fusibile lama Uni con led	BROWN
3520102725	10A fusibile lama Uni con led	RED
3520102730	15A fusibile lama Uni con led	LIGHT BLUE
3520102735	20A fusibile lama Uni con led	YELLOW
3520102740	25A fusibile lama Uni con led	TRANSPARENT
3520102745	30A fusibile lama Uni con led	GREEN

Blade micro fuses

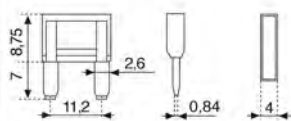

Code	Descriz. <i>corr. nom. (In)</i>	Body color
3520101800	2 A	GREY
3520101900	3 A	VIOLET
3520102000	4 A	PINK
3520102100	5 A	BEIGE
3520102200	7.5 A	BROWN
3520102300	10 A	RED
3520102400	15 A	BLUE
3520102500	20 A	YELLOW
3520102600	25 A	NEUTRAL
3520102700	30 A	GREEN

Micro blade fuses with Led



- In accordance with the general rules SAE J 1284
- They have an LED that lights up following the fuser interruption
- Self-extinguishing
- Dimensions as standard UNI.

3

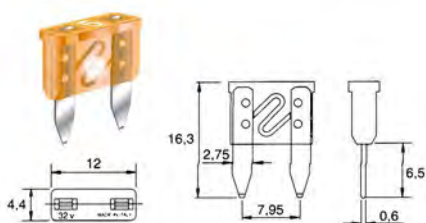

Code	Descriz. <i>corr. nom. (In)</i>	Body color
3520102750	2A micro fusibile con led	GREY
3520102755	3A micro fusibile con led	VIOLET
3520102760	4A micro fusibile con led	PINK
3520102765	5A micro fusibile con led	BEIGE
3520102770	7,5A micro fusibile con led	BROWN
3520102775	10A micro fusibile con led	RED
3520102780	15A micro fusibile con led	LIGHT BLUE
3520102785	20A micro fusibile con led	YELLOW
3520102790	25A micro fusibile con led	WHITE
3520102795	30A micro fusibile con led	GREEN

Micro2 blade fuses



- The 32 V micro2 fuses are the new standard for vehicle circuit protection.

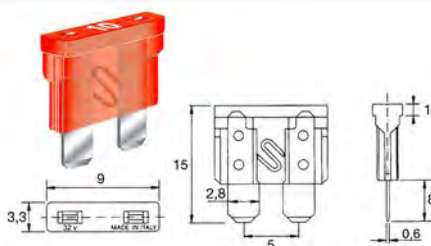

Code	Descriz. <i>corr. nom. (In)</i>	Body color
3520102800	5A micro2 fuse 32V	BEIGE
3520102805	7,5A micro2 fuse 32V	BROWN
3520102810	10A micro2 fuse 32V	RED
3520102815	15A micro2 fuse 32V	LIGHT BLUE
3520102820	20A micro2 fuse 32V	YELLOW
3520102825	25A micro2 fuse 32V	WHITE
3520102830	30A micro2 fuse 32V	GREEN

Maxi blade fuses

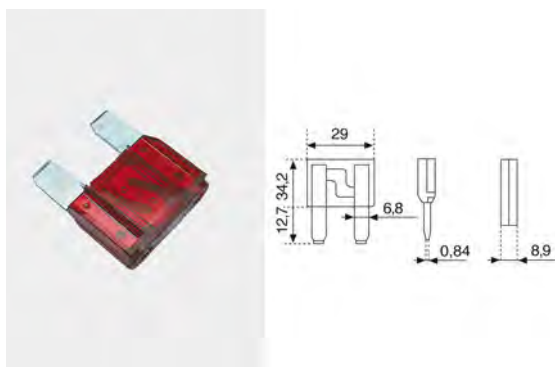

Code	Descriz. <i>corr. nom. (In)</i>	Body color
3520101000	20 A	YELLOW
3520101100	30 A	GREEN
3520101200	40 A	ORANGE
3520101300	50 A	RED
3520101400	60 A	BLUE
3520101500	70 A	BROWN
3520101600	80 A	NEUTRAL
3520101700	100 A	VIOLET

- Designed for short circuit protection of electrical flow in which high values of rated current (In).

Micro3 blade fuses

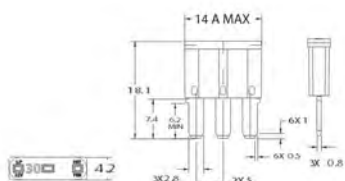

- The 32 V micro3 fuses are the new standard for vehicle circuit protection.

Code	Descriz. <i>corr. nom. (In)</i>	Body color
3520102835	5A micro3 fuse	Beige
3520102840	7,5A micro3 fuse	Brown
3520102845	10A micro3 fuse	Red
3520102850	15A micro3 fuse	Light blue

Low-profile fuses



Code	Desc.	Color	Amperage (A)
3580002900	2A	GREY	2
3580002910	3A	VIOLET	3
3580002920	4A	PINK	4
3580002930	5A	BEIGE	5
3580002940	7,5A	BROWN	7,5
3580002950	10A	RED	10
3580002960	15A	BLUE	15
3580002970	20A	YELLOW	20
3580002980	25A	NATURAL	25
3580002990	30A	GREEN	30

- Blade fuses, for Japanese cars.
- The particular shape of the fuse contact makes it suitable for replacement of the car market Eastern Europe.
- Max fuse size: 11x9 mm.

Cylindrical fuses plastic foil

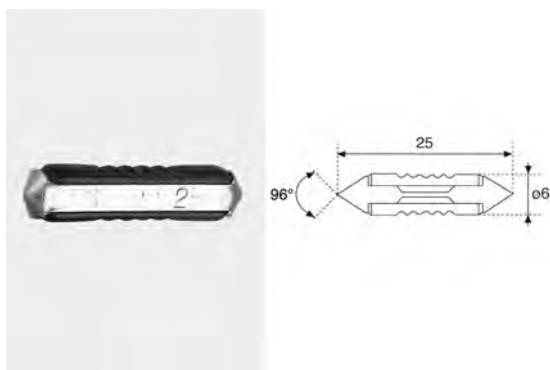

Code	Descriz. <i>corr. nom. (In)</i>	Body color	Original ref.
3500100100	5 A - L 25	YELLOW	FIAT 9.91806
3500000100	8 A - L 25	BLACK	FIAT 9.91806
3500100200	8 A - L 25	WHITE	DIN72581
3500000150	10 A - L 25	WHITE	-
3500000200	16 A - L 25	GREEN	FIAT 9.91806
3500100300	16 A - L 25	RED	DIN72581
3500000300	25 A - L 25	BROWN	FIAT 9.91806
3500100400	25 A - L 25	BLUE	DIN72581
3500000400	40 A - L 25	RED	-

- Available in the original references: Fiat, DIN.

Cylindrical fuses fast glass

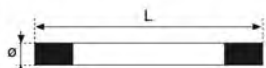

- Available in two sizes, different amperage, voltage to 12-24 V.

Code	Descriz. <i>corr. nom. (In)</i>	Dim. mm
3530000060	500 MA	5 x 20
3530000100	1 A - L 20	5 x 20
3530000200	2 A - L 20	5 x 20
3530000300	3 A - L 20	5 x 20
3530000400	4 A - L 20	5 x 20
3530000500	5 A - L 20	5 x 20
3530000600	6 A - L 20	5 x 20
3530000700	10 A - L 20	5 x 20
3530000720	20 A - L 20	5 x 20
3530000730	1 A - L 32	6.3 x 32
3530000735	2 A - L 32	6.3 x 32
3530000750	3 A - L 32	6.3 x 32
3530000800	5 A - L 32	6.3 x 32
3530000900	8 A - L 32	6.3 x 32
3530001000	10 A - L 32	6.3 x 32
3530001100	16 A - L 32	6.3 x 32
3530001150	20 A - L 32	6.3 x 32
3530001200	25 A - L 32	6.3 x 32
3530001300	30 A - L 32	6.3 x 32



Fuses for Japanese cars with female coupling series AS

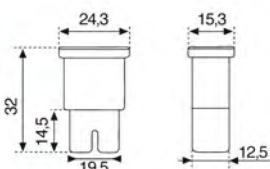

- Mounted group cars: Chrysler, Daihatsu, Ford, Hunday, Kia, Mazda, Mitsubishi, Nissan, Rover, Ss. Yong, Subaru, Suzuki, Toyota, Vauxhall.

Code	Descriz. <i>corr. nom. (In)</i>	Body color	Series
3580000050	20 A - FEMALE	LIGHT BLUE	AS
3580000100	30 A - FEMALE	PINK	AS
3580000200	40 A - FEMALE	GREEN	AS
3580000250	50 A - FEMALE	RED	AS
3580000300	60 A - FEMALE	YELLOW	AS
3580000310	80 A - FEMALE	BLACK	AS
3580000320	100 A - FEMALE	BLUE	AS

Fuses for Japanese cars with male connection series B/BT

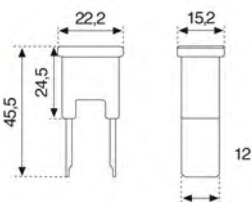

- Mounted group cars: Ford, Hyundai, Mazda, Mitsubishi, Nissan, Rover, Ss. Yong, Suzuki, Toyota, Vauxhall.

Code	Descriz. <i>corr. nom. (In)</i>	Body color	Series
3580000400	30 A - MALE	PINK	B/BT
3580000420	40 A - MALE	GREEN	B/BT
3580000440	50 A - MALE	RED	B/BT
3580000500	60 A - MALE	YELLOW	B/BT
3580000550	70 A - MALE	GREY	B/BT
3580000600	80 A - MALE	BLACK	B/BT
3580000700	100 A - MALE	BLUE	B/BT

Fuses for Japanese cars with female coupling and retention

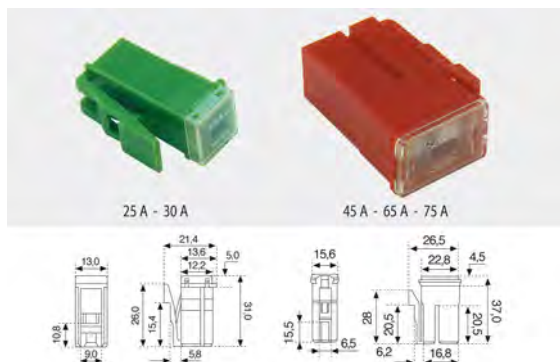

- Mounted group cars: Ford, Honda, Nissan, Subaru.

Code	Descriz. <i>corr. nom. (In)</i>	Body color	Series
3580002200	25 A - R-FEMALE	BROWN	D
3580002300	30 A - R-FEMALE	GREEN	D
3580002400	45 A - R-FEMALE	RED	E
3580002600	75 A - R-FEMALE	GREY	E

Mini fuses for Japanese cars MF14 series Jcase

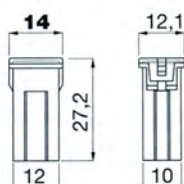

- Female coupling.
- The different colors identify the different amperage.
- With dimensions of 14 mm.

Code	Descriz. <i>corr. nom. (In)</i>	Color
3580002700	20A-MF14-FEMALE	LIGHT BLUE
3580002710	30A-MF14-FEMALE	PINK
3580002720	40A-MF14-FEMALE	GREEN
3580002730	50A-MF14-FEMALE	RED
3580002740	60A-MF14-FEMALE	YELLOW

Mini fuses for Japanese cars MF18 series F

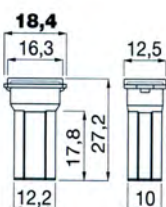

- Female coupling.
- The different colors identify the different amperage.
- With dimensions of 18 mm.

Code	Descriz. <i>corr. nom. (In)</i>	Color
3580002800	30A-MF18-FEMALE	PINK
3580002810	40A-MF18-FEMALE	GREEN

Japanese fuses Jcase M series



- Reduced Series but same attack of normal JCASE series, Also mounted in the first plant of European cars such as Ford-Fiat-Chrysler group.

Code	Descriz. <i>corr. nom. (In)</i>	Body color
3580003035	20 A Mini fuse Jcase	Light blue
3580003040	25 A Mini fuse Jcase	White
3580003045	30 A Mini fuse Jcase	Pink
3580003050	40 A Mini fuse Jcase	Green
3580003055	50 A Mini fuse Jcase	Red
3580003060	60 A Mini fuse Jcase	Yellow

Mega fuses for car

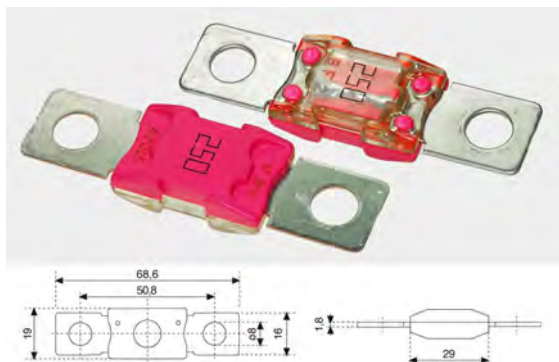

- Fuses mega 32V indicated for the protection of batteries and alternators.

Code	Descriz. <i>corr. nom. (In)</i>	Body color
3580100100	100 A	Yellow
3580100200	125 A	Green
3580100300	150 A	Orange
3580100400	200 A	Blue
3580100410	225 A	Beige
3580100420	250 A	Pink
3580100500	300 A	Grey
3580100600	400 A	Violet
3580100610	500 A - specifically for stralis	Brown

Fuses midi for car

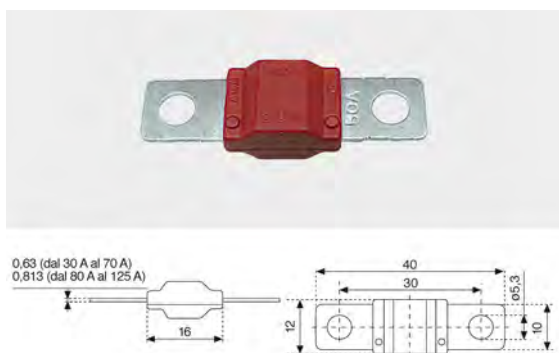

- Midi 32V socket fuses with Bolted alternative to maxi fuses and tape.
- Fuse inserted in our art. 354 00 01900-53055.

Code	Descriz. <i>corr. nom. (In)</i>	Body color
3580200050	30 A	PINK
3580200100	40 A	GREEN
3580200150	50 A	RED
3580200200	60 A	YELLOW
3580200250	70 A	BROWN
3580200300	80 A	WHITE
3580200350	100 A	BLUE
3580200400	125 A	ORANGE

80 Volt fuses with ceramic protection for battery vehicles



- The band fuses with ceramic protection are suitable for battery-powered vehicles, such as forklifts.
- With window for visual inspection for the fusion elements.

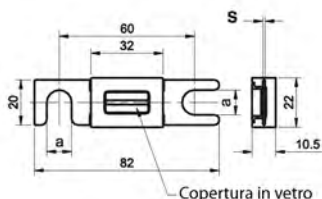

Code	Description	Ampere
3580003000	50 A ceramic fuse	50
3580003005	80 A ceramic fuse	80
3580003008	100 A ceramic fuse	100
3580003010	150 A ceramic fuse	150
3580003015	250 A ceramic fuse	250
3580003020	355 A ceramic fuse	355
3580003025	400 A ceramic fuse	400
3580003030	500 A ceramic fuse	500

Fuses tape



Code	Descriz. <i>corr. nom. (In)</i>
3490000400	25 A
3490000030	30 A
3490000040	40 A
3490000100	50 A
3490000120	60 A
3490000200	80 A
3490000300	100 A



- Made from zinc ribbon with shiny surface in accordance with DIN 72581/2.
- To protect circuits crossed by high current such as diesel glow plugs, alternators, starters, air conditioning, automatic transmission, power seats.

Assortment fuses various



- Contents: 16 bars of laminated cylindrical fuses 8 to 40A, DIN 5 to 25A, 40 and 50A diesel cars, EEC standards 7.5 to 30A.
- Total 400 pieces.
- Supplied in a plastic carrying case our cod. 398 00 01900 ABH4.

Code	Desc.
3500300100	16

Contenuto kit

CODICE	DESCRIZIONE	Q.tà
3500000300	25A-L25-FUSIBILE LAMELLARE	25
3500000400	40A-L25-FUSIBILE LAMELLARE	25
3500100100	5A-L25-FUSIBILE DIN V.TEDESCHE	25
3500100200	8A-L25-FUSIBILE DIN V.TEDESCHE	25
3500100400	25A-L25-FUSIBILE DIN V.TEDESC.	25
3490000100	50A-FUSIBILE VETTURE DIESEL	25
3520100300	7.5A-FUSIBILE NORME CEE	25
3520100400	10A -FUSIBILE NORME CEE	25
3520100500	15A -FUSIBILE NORME CEE	25
3520100600	20A -FUSIBILE NORME CEE	25
3520100700	25A -FUSIBILE NORME CEE	25
3520100800	30A -FUSIBILE NORME CEE	25
3490000040	40A-FUSIBILE VETTURE DIESEL	25
3500000200	16A-L25-FUSIBILE LAMELLARE	25
3500000100	8A-L25 -FUSIBILE LAMELLARE	25
3500100300	16A-L25-FUSIBILE DIN V.TEDESC.	25

Assortment blade fuses EEC standards



- Contents: 12 measures of fuses from 1A to 40A EEC standards.
- Total 120 pieces.
- Supplied in a plastic carrying case our cod. 398 00 01700 200.

Code	Desc.
3520200100	12

Contenuto kit

CODICE	DESCRIZIONE	Q.tà
3520100020	2A -FUSIBILE NORME CEE	10
3520100010	1A -FUSIBILE NORME CEE	10
3520100100	3A -FUSIBILE NORME CEE	10
3520100150	4A -FUSIBILE NORME CEE	10
3520100200	5A -FUSIBILE NORME CEE	10
3520100300	7.5A-FUSIBILE NORME CEE	10
3520100400	10A -FUSIBILE NORME CEE	10
3520100500	15A -FUSIBILE NORME CEE	10
3520100600	20A -FUSIBILE NORME CEE	10
3520100700	25A -FUSIBILE NORME CEE	10
3520100800	30A -FUSIBILE NORME CEE	10
3520100840	40A-FUSIBILE NORME CEE	10

Assortment micro blade fuses



- Content: 12 measures micro blade fuses 2A to 30A
- Total 60 pieces
- Supplied in a plastic carrying case n / s cod. 398 00 01 700 200

Code	Desc.
3520200300	12

Contenuto kit

CODICE	DESCRIZIONE	Q.tà
3520101800	2A -MICROFUSIBILE A LAMA	5
3520101900	3A -MICROFUSIBILE A LAMA	5
3520102000	4A -MICROFUSIBILE A LAMA	5
3520102100	5A -MICROFUSIBILE A LAMA	5
3520102200	7.5A -MICROFUSIBILE A LAMA	5
3520102300	10A -MICROFUSIBILE A LAMA	10
3520102400	15A -MICROFUSIBILE A LAMA	25
3520102500	20A -MICROFUSIBILE A LAMA	5
3520102600	25A -MICROFUSIBILE A LAMA	5
3520102700	30A -MICROFUSIBILE A LAMA	5

Assortment maxi blade fuses



- Contents: 12 measurements max plug fuse 20A 100A has.
- Total 24 pieces.
- Supplied in plastic case our cod. 398 00 01700 200.

Code	Desc.
3520200200	12

Contenuto kit

CODICE	DESCRIZIONE	Q.tà
3520101000	20A -MAXIFUSIBILE A LAMA	2
3520101100	30A -MAXIFUSIBILE A LAMA	2
3520101200	40A -MAXIFUSIBILE A LAMA	2
3520101300	50A -MAXIFUSIBILE A LAMA	2
3520101400	60A -MAXIFUSIBILE A LAMA	4
3520101500	70A -MAXIFUSIBILE A LAMA	4
3520101600	80A -MAXIFUSIBILE A LAMA	4
3520101700	100A -MAXIFUSIBILE A LAMA	4

Assorted glass fuses



- Contents: 12 sizes of glass fuses from 1A to 10A length 20mm 3A to 25A length 32mm.
- Total 240 pieces.
- Supplied in a plastic carrying case our cod. 398 00 01700 200.

Code	Desc.
3530100100	12

Contenuto kit

CODICE	DESCRIZIONE	Q.tà
3530000100	1A-L20 -FUSIBILE VETRO	20
3530000200	2A-L20 -FUSIBILE VETRO	20
3530000300	3A-L20 -FUSIBILE VETRO	20
3530000500	5A-L20 -FUSIBILE VETRO	20
3530000600	6A-L20 -FUSIBILE VETRO	20
3530000700	10A-L20-FUSIBILE VETRO	40
3530000750	3A-L32 -FUSIBILE VETRO	20
3530000800	5A-L32 -FUSIBILE VETRO	20
3530001000	10A-L32-FUSIBILE VETRO	20
3530001100	15A-L32-FUSIBILE VETRO	20
3530001200	25A-L32-FUSIBILE VETRO	20

Fuse holder steering wheel to fuse plastic foil



- Fuse holder in plastic with connection cables for female faston step 6.3, bayonet.
- For fuses plastic foil our cod. 350 00, 350 01 l. 25 mm.

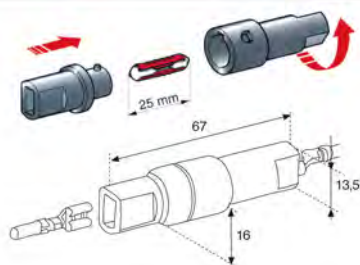

Code	Desc.
3540000700	53038

Fuse holder steering wheel to fuse plastic foil



- Fuse holder in plastic material with tightening the thumbscrew cables, bayonet lock.
- For fuses plastic foil our cod. 350 00, 350 01 l. 25 mm.

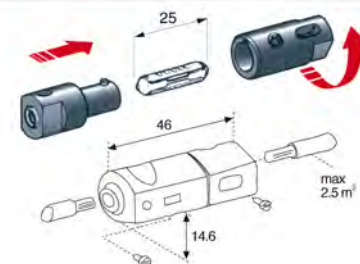

Code	Desc.	Cable sec. min-max mm ²
3540000100	35 A	FROM 0,25 TO 2,5

Flying fuse holder for glass fuses



- For glass fuses size 5x20 our art. 353 00.
- Cable fasteners screw.
- Bayonet lock.

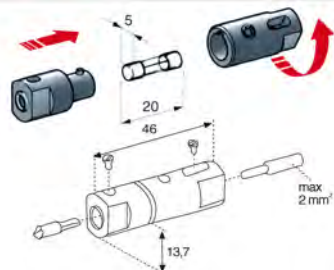

Code	Desc.	Cable sec. min-max mm ²
3540002100	53057	FROM 0,25 TO 2

Flying fuse holder for blade fuses



- Fuse holder thermoplastic splash resistant.
- Complete with two pieces of wire section. 1.5 mm² 20 cm long.

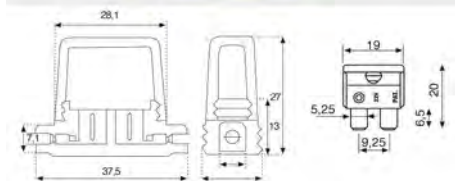

Code	Desc.
3540004100	53077

Fuse holder with derivation

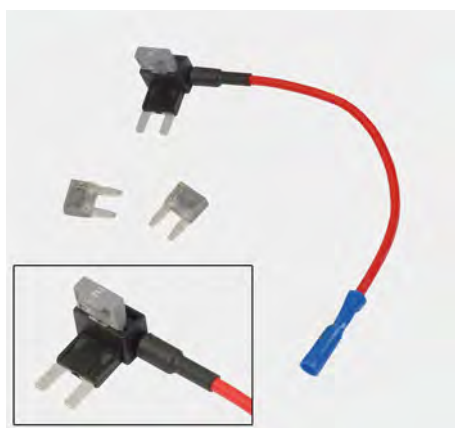

- Holder with derivation.
- To install electrical accessories seamless.
- Quick and easy to install thanks to pluggable terminal to replace the fuse.
- Supplied without fuses.
- Cable length 12 cm.
- Pre-insulated connector cables section 1-2.5 mm².

Code	Desc.	Application
3540004400	53080	Micro fuse blade
3540004410	53090	Blade fuse

Steering wheel for blade fuse holder microfusibili



- Fuse holder thermoplastic splash resistant.
- Complete with two pieces of wire 1.5 mm² 20 cm long.

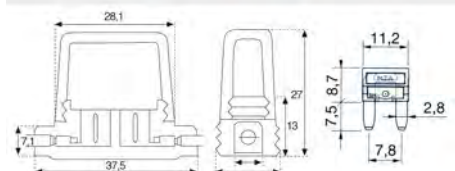

Code	Desc.
3540004000	53076

1 way modular fuse holder for blade fuses



- Fuse holder plastic max 16 A.
- You can fit together pieces to get the number of channels desired.

Code	Desc.	Terminal to be used
3540001100	53047	317 00 21260 - 52277

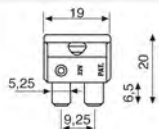

1 way modular fuse holder for blade fuses



- Fuse holder in plastic with two couplings for female faston mis. 6.3.
- You can fit together pieces to get the number of channels desired.
- Can be fixed to the wall with our art. 354 00 01300-53049.

Code	Desc.
3540001200	53048

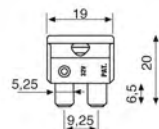

1 way modular fuse holder for blade fuses



- Fuse holder in plastic with two couplings for female faston mis. 6.3.
- You can fit together pieces to get the number of channels desired.
- Can be fixed to the wall with our art. 354 00 01300-53049.
- Complete with lid for hs fuse. code 3540001400 - 53050

Code	Desc.	Replacement terminal
3540003100	53067	317 00 22155 - 52454

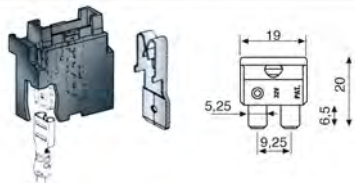

Cover for protection fuse



- Cover in transparent plastic material for fuse holder art. 354 00 03100-53067.

Code	Desc.
3540001400	53050



1 way modular fuse holder for blade fuses

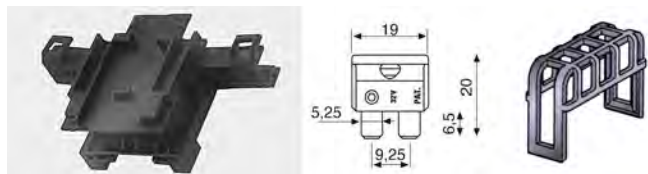

- Fuse holder plastic without terminals.
- You can fit together pieces to get the number of channels desired.
- Can be fixed to the wall with ours. art. 354 00 03300 - 53069.

Code	Desc.	Color	Installable terminal
3540003200	53068NE	BLACK	317 00 22155 - 52446
3540003240	53068GA	-	CAGE PROTECTION

Fuse holder "in line" for blade fuses



- Fuse terminal for applying online for auto blade fuses.
- Applications for protection of: electrical systems, radio equipment, lighting systems, security systems, ventilation and air conditioning.

Code	Desc.	Cable sec. min-max mm ²	voltage max V.	Temp. max °C
3540000900	53040	FROM 0,75 TO 2	32	105

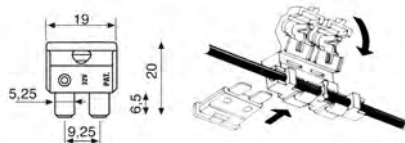

Modular fuse holder for blade maxi fuses



- Plastic body holder for blade maxi fuses supplied without terminals.
- You can fit together pieces to get the number of channels desired.
- Can be fixed to the wall with our art. 354 00 03300 - 53069

Code	Desc.	Original ref.	Installable terminal
3540001800	53054	FIAT 1/92061/87	3170021715-52366 / 3170021720-52367 / 3170021725-52368 / 3170021845-52392

Cover for protection fuse



- Cover in transparent plastic material for our fuse holder art. 354 00 01800-53054

Code	Desc.	Original ref.
3540003700	53073	FIAT 1/92058/94

Fuse holder for tape and midi

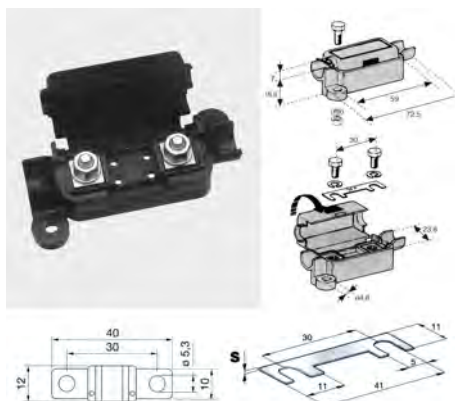

- Fuse holder in plastic material with tightening screw for our fuses tape cod 349 00 with hole spacing of 30 mm and midi cod. 358 02.
- Suitable for circuit protection of glow plugs of diesel cars.
- Supplied without fuse with two brass screws and two washers tin.
- Maximum cable section 6 mm².

Code	Desc.
3540001900	53055

Fuse holder for Mega fuse



- Mega fuse holder with 2 M8 pins and cover.
- Supplied without fuse

Code	Description
3540004420	Fuse holder for Mega

Fuse holder for ceramic fuses 80 Volt



- Fuse holder for ceramic fuses with 2 M8 pins and cover.
- Supplied without fuse.

Code	Description
3540004430	Fuse holder for ceramic

Fuse holder 1 way modular splash-proof for blade fuses



- Fuse holder in plastic material with watertight cover.
- You can fit together pieces to get the number of channels desired.
- Can be fixed to the wall with our art. 354 00 03300 - 53069.
- Terminals installed: our cod. 317 00 22,145 to 52,452.

Code	Desc.	Color secondarylock and corr. max applicable
3540004200	53078	GREEN- 30 A

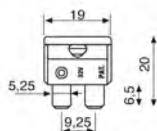

3

Fuse holder 1 way modular splash-proof for maxi blade fuses



- Fuse holder in plastic material with watertight cover.
- You can fit together pieces to get the number of channels desired.
- Can be fixed to the wall with our art. 354 00 03300 - 53069.
- Supplied with two terminals our art. 317 00 21,720 to 52,367.
- With the bottom cover can be installed cable sect. max 6 mm², without bottom cover section, you can install cables up to 16 mm².
- Terminals installed: Our art. 317 00 21715-52366 / 317 00 21720-52367 / 317 00 21725 to 52368.

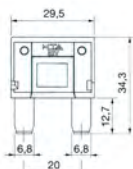

Code	Desc.
3540004300	53079

Fixing plates to fuse

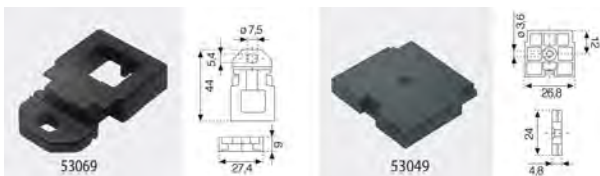

- Platelets in plastic material with screw attachment for the anchorage of our modular fuse holder.

Code	Desc.	For fuse carriers
3540003300	53069	354 00 01800 - 53054 354 00 03200 - 53068 354 00 04200 - 53078 354 00 04300 - 53079
3540001300	53049	354 00 01200 - 53048 354 00 00800 - 530639 354 00 03100 - 53067

Micro Relays 12 Volt and 24-Volt normally open with resistance- 4 contacts



- It is a remote control switch for continuous service used in motor vehicles, in closing agent of the load circuit.
- It is a micro relay, therefore with reduced size than standard Relays.
- Reduce the maximum voltage.

Code	Description
3170026330	20 amp-12 volt-open
3170026335	30 amp-12 volt- open
3170026340	10 amp-24 volt- open

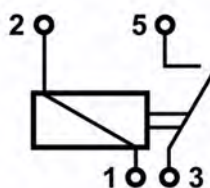

Micro Relays 12-volt and 24-volt in exchange with resistance- 5 contact



- It is a remote control switch for continuous service used in motor vehicles, in closing agent of the load circuit.
- It is a micro relay, therefore with reduced size than standard Relays.
- Reduce the maximum voltage.

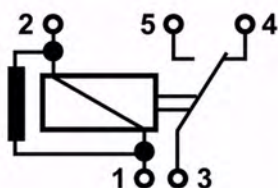

Code	Description
3170026345	10-20 amp-12 volt- in exchange
3170026350	10-20 amp-24 volt- in exchange

Relays 12 Volt and 24-Volt normally open with resistance- 5 contacts (6,3x0,8)



- It is a remote control switch for continuous service used in motor vehicles, in closing agent of the load circuit.
- It is a micro relay, therefore with reduced size than standard Relays.
- Reduce the maximum voltage.

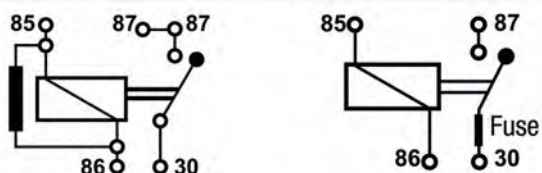

Code	Description	Characteristics
3170026355	40 amp-12 vot-open	With removable bracket
3170026360	30 amp-12 volt- open	With fuse and removable bracket, specifically nautical sector
3170026365	30 amp-24 volt- open	With fixed bracket
3170026370	20 amp-24 volt- open	With fuse and removable bracket, specifically nautical sector

3

Relays 12 volts and 24 volts in exchange with resistance- 5 contacts (6.3x0.8)

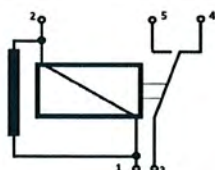

- It is a remote control switch for continuous service used in motor vehicles, in closing agent of the load circuit.
- It is a micro relay, therefore with reduced size than standard Relays.
- Reduce the maximum voltage.

Code	Description	Characteristics
3170026375	20-30 amp-12 volt-in exchange	With removable bracket
3170026380	10-20 amp-24 volt-in exchange	With removable bracket -Rif. IVECO 4718222

Relays 12-volt and 24-volt power -normally open with resistance- 4 contacts (2x6,3x0,8,2x9,5x1,2)

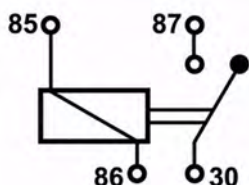

- It is a remote control switch for continuous service used in motor vehicles, in closing agent of the load circuit.
- It is a micro relay, therefore with reduced size than standard Relays.
- Reduce the maximum voltage.

Code	Description	Characteristics
3170026385	70 amp-12 volt-open DP	With removable, special bracket for yachting and industrial vehicles
3170026390	70 amp-24 volt-open DP	Rif. IVECO 4718222

Brings power relay 4-way

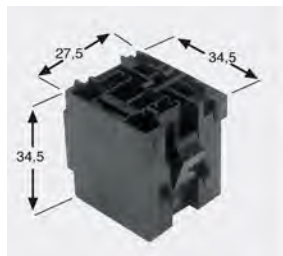

- Wall mountable with our platelets cod. 354 354 00 00 03,300 to 53,069 03,400 to 53,070.
- Terminal to install: N° 2 317 00 21625-52348; 317 00 03810-1422.

Code	Desc.
3170022560	52534

5 ways to block micro relay

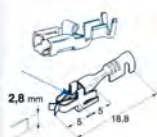
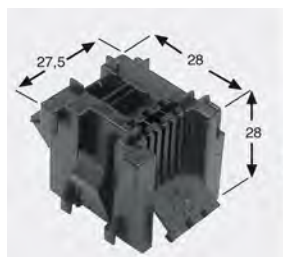

- Terminal to install: N° 2 317 00 21625 to 52348; N° 3 317 00 08050-26178; 317 00 08052-26179.

Code	Desc.
3170022555	52533

5 ways to block modular relay standard



- Wall mountable with the ns. platelets cod. art. 354 00 03300 53069; 354 00 03,400 to 53,070
- Terminal to install: N° 5 317 00 02700- 1404

Code	Desc.
3170021110	52247

Block for micro relay

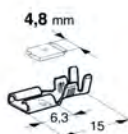
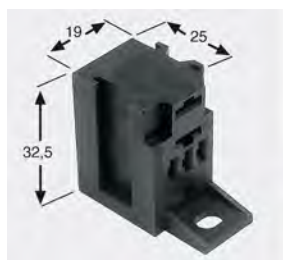

- Block door contact with screw or multiple interlocking.
- Terminal to install: N° 2 317 00 02700-1404; 317 00 02710-1404 / B; 317 00 02720-1405; N° 3 317 00 20,800 to 52,231.

Code	Desc.
3170025380	52638

Block for intermittent relay

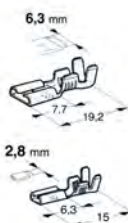

- Block door contact with screw or multiple interlocking.
- Terminal to install: N° 5 317 00 02700-1404; 317 00 02710-1404 / B; 317 00 02720-1405; N° 4 317 00 21125-52250.

Code	Desc.
3170025390	52639

Block for power relays and control units preheating

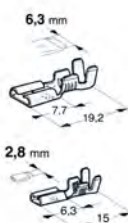
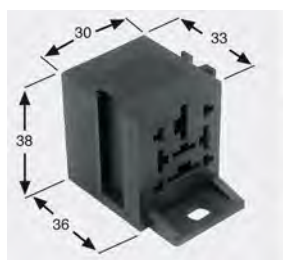

- Block door contact with screw or multiple interlocking.
- Terminal to install: N° 2 317 00 03810-1422 / N ° 3317 00 02700-1404; 317 00 02710-1404 / B; 317 00 02720-1405 / N° 4317 00 21125-52250.

Code	Desc.
3170025400	52640

