

## Terminal covers Nylon

3

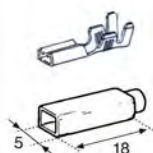

- Resistant to temperature, oil, gasoline etc.
- Satisfying the requirements provided for by the higher specifications.

Code	Desc.	Original ref.	Step
3170002910	1411	FIAT 1/23331/87	2,8

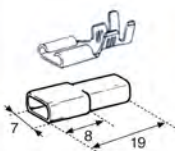

- For female terminals: 317 00 07300-18638

Code	Desc.	Original ref.	Step
3170007310	18639	-	4,7

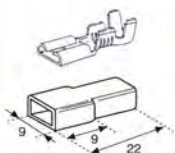

- For female terminals: 317 00 02550-1402.

Code	Desc.	Original ref.	Step
3170004620	1440	-	6,3

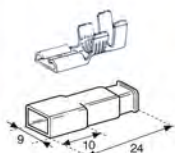

- For female terminals: 317 00 02600-1403 31700 02610-1403 / B.

Code	Desc.	Color	Step
3170000600	1008	BLACK	6,3
3170004400	1430	RED	6,3

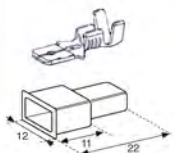

- For male terminals: 317 00 04600-1439 31700 04610-1409 / B

Code	Desc.	Color	Step
3170004500	1431	BLACK	6,3

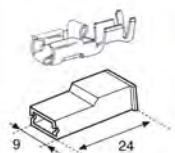

- For female terminals: 317 00 21625-52348

Code	Desc.	Original ref.	Step
3170021660	52355	FIAT 1/23387/87	6,3



- For female terminals: 317 00 25700-52700.

Code	Desc.	Original ref.	Step
3170005105	1447	FIAT 1/23371/87	6,3

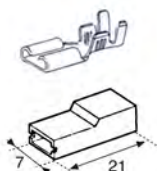

- For female terminals: 317 00 07300-18638

Code	Desc.	Original ref.	Step
3170021640	52351	FIAT 1/23335/80	4,7

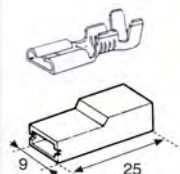

- For female terminals: 317 00 02600-1403 317 00 02610-1403 / B.

Code	Desc.	Original ref.	Step
3170021645	52352	FIAT 1/20558/80	6,3

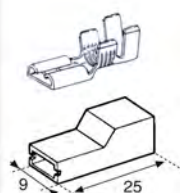

- For female terminals: 317 00 02550-1402

Code	Desc.	Original ref.	Step
3170021650	52353	FIAT 1/20559/80	6,3

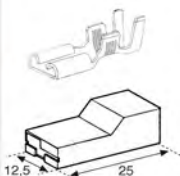

- Resistant to temperature, oil, petrol etc ..
- Satisfying the requirements provided for by the higher specifications.
- For female terminals: 317 00 03900-1423.

Code	Desc.	Original ref.	Step
3170021655	52354	FIAT 1/20557/85	9,5

## Holder blocks females 3-way lamps H4

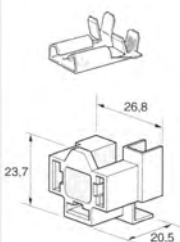

- Block port terminals for lamps with asymmetric attack + H4.
- White color.
- For female terminals: 317 00 21320 to 52289.

Code	Desc.	Original ref.	Step
3170021085	52242	FIAT 1/02579/80	7,7

3

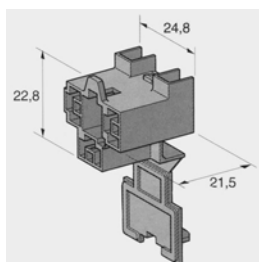

- With inspection door
- Black Colour
- Terminal flag inserted: 317 00 25730-52703 - Step 7.7

Code	Desc.
3170025720	52702

## Female terminal holder 2-way lamps H7

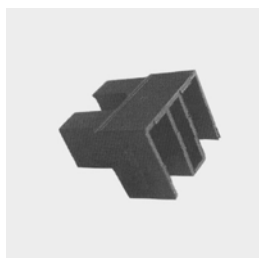

- Terminal fraying inserted: 317 00 25700-52700 - Step 6.3

Code	Desc.
3170025710	52701

## Wired lamp holders connector



- Pre-wired connectors for automotive lamps.

Code	Description	For lamps
3170026400	H4-wired connector	H4



- Pre-wired connectors for automotive lamps.

Code	Description	For lamps
3170026410	H7-wired connector	H7



- Pre-wired connectors for automotive lamps.

Code	Description	For lamps
3170026420	H8-H11 wired connector	H8 and H11



- Pre-wired connectors for automotive lamps.

Code	Description	For lamps
3170026430	HB3-wired connector	HB3



- Pre-wired connectors for automotive lamps.

Code	Description	For lamps
3170026440	HB4-wired connector	HB4



- Pre-wired connectors for automotive lamps.

Code	Description	For lamps
3170026450	TV- all glass wired connector	For all glass

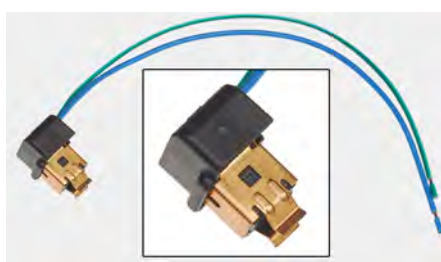

- Pre-wired connectors for automotive lamps.

Code	Description	For lamps
3170026460	H1-wired connector	H1

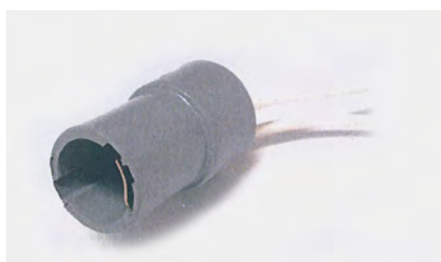

- Pre-wired connectors for automotive lamps.

Code	Description	For lamps
3170026470	H6-wired connector	H6



- Pre-wired connectors for automotive lamps.

Code	Description	For lamps
3170026475	ND- wired connector fog light New Daily	H7

## Connectors for male and female terminals with retaining tooth step 6.3



- Terminals installable on all connectors.
- Male, C / tooth step 6.3.

Code	Desc.	Cable sec. mm <sup>2</sup>	Material
3170002960	1412/1	0.3 - 0.8	RAW BRASS
3170003000	1413	1 - 2.5	RAW BRASS
3170003010	1413/B	1 - 2.5	TINNED BRASS
3170002950	1412	4 - 6	TINNED BRASS

- Terminals installable on all connectors.
- Female, C / tooth step 6.3.



Code	Desc.	Cable sec. <i>mm<sup>2</sup></i>	Material
3170002700	1404	1 - 2.5	RAW BRASS
3170002710	1404/B	1 - 2.5	TINNED BRASS
3170002720	1405	4 - 6	OTTONE STAGNATO

3

### Connectors for terminals with M. and F. retaining tooth pitch. 6.3



- 1 way male

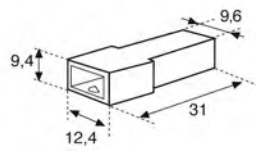

Code	Desc.	Original ref.
3170000700	1015	FIAT 1 20589 80



- 1 way female

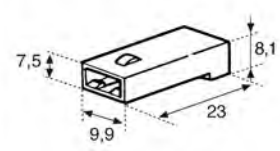

Code	Desc.	Original ref.
3170000800	1016	FIAT 1 20590 80



- 2-way male

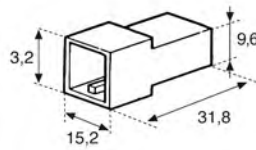

Code	Desc.	Original ref.
3170000900	1017	FIAT 1 20605 80



- 2 way female

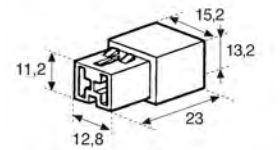

Code	Desc.	Original ref.
3170001000	1018	FIAT 1 20604 80



- 2-way "T" male

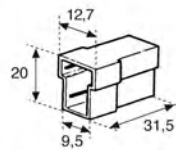

Code	Desc.	Original ref.
3170001100	1019	FIAT 1 20599 80



- 2 way "T" female

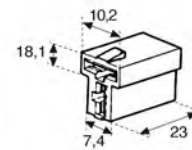

Code	Desc.	Original ref.
3170001200	1020	FIAT 1 20598 80



- 3 way male.

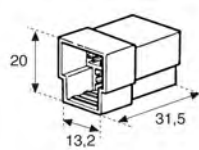

Code	Desc.	Original ref.
3170001300	1021	FIAT 1 20668 80



- 3 way female.

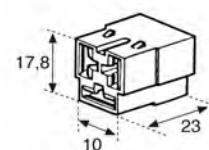

Code	Desc.	Original ref.
3170001400	1022	FIAT 1 20667 80





• 4 way male.

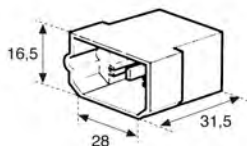

Code	Desc.	Original ref.
3170001500	1023	FIAT 1 20581 80



• 4 way female

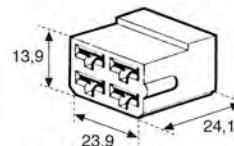

Code	Desc.	Original ref.
3170001600	1024	FIAT 1 20580 80



• 6 way male

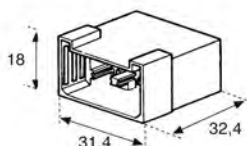

Code	Desc.	Original ref.
3170001700	1025	FIAT 1 02504 80



• 6 way female

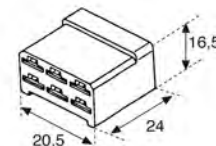

Code	Desc.	Original ref.
3170002400	1033	-



• 6 ways female with wings.

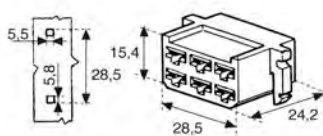

Code	Desc.	Original ref.
3170001800	1026	FIAT 1 02503 80



• 6 way male with wings

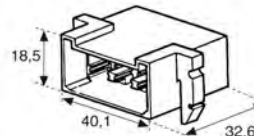

Code	Desc.	Original ref.
3170001900	1027	FIAT 1 20611 80



• 8 way female

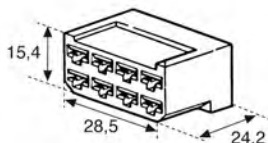

Code	Desc.	Original ref.
3170002000	1028	FIAT 1 20606 80



• 8-way male

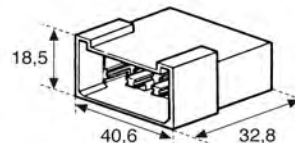

Code	Desc.	Original ref.
3170002100	1029	FIAT 1 20607 80

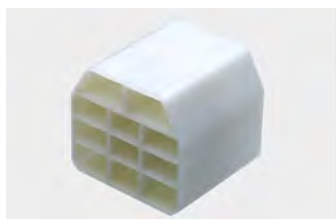

• 11 way male

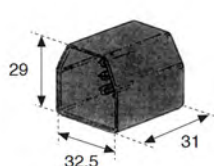

Code	Desc.	Original ref.
3170000630	1012	FIAT 1 20625 87



• 11 way female

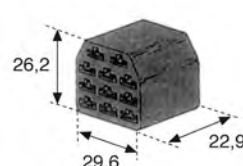

Code	Desc.	Original ref.
3170000650	1013	FIAT 1 20624 87

## Holder block females mixed two-way



- Application: Iveco truck.

Code	Desc.	N° Way
3170025780	52708	2



- Terminals pluggable female

Code	Step
3170003810-1422	9,5
3170002700-1404	6,3

## Holder block male mixed piggyba

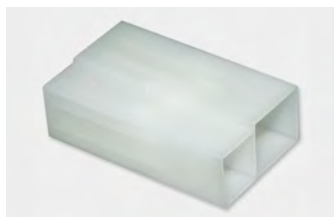

Code	Desc.	N° Way
3170025790	52709	2



Code	Step
3170003000-1413	6,3
3170003820-1422/1	9,5

## Holder blocks females per-pin terminals

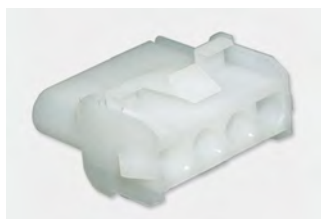

Code	Desc.	N° Way
3170025800	52710	1
3170025810	52711	2
3170025820	52712	3
3170025830	52713	4
3170025840	52714	6 3x2
3170025850	52715	9 3x3
3170025860	52716	12 3x4
3170025870	52717	15 3x5



Code	Sez. cable
3170021790-52381	0,5-2,0

- Series Mate-n-lock.
- For various applications.
- 6=3x3 - 12=3x4 - 15=3x5

- Pluggable terminal female

## Blocks series male mate-n-lock-pin terminals



Code	Desc.	N° Way
3170025890	52719	1
3170025900	52720	2
3170025910	52721	3
3170025920	52722	4
3170025930	52723	6 3x2
3170025940	52724	9 3x3
3170025950	52725	12 3x4
3170025960	52726	15 3x5



Code	Sez. cable
3170021785-52380	0,5-2,0

- Series Mate-n-lock.
- For various applications.
- N-way 6 = 3x2 - 9 = 3x3 - 3x4 = 12 - 15 = 3x5

- Selectable terminating male

## Port connectors female Sigma series II



- Application: engine sensors.

Code	Desc.	N° Way
3170026130	52743	2
3170026140	52744	3
3170026150	52745	4



- Female terminal sigma series II

Code	Desc.	Sez. cable
3170022595	52541	0,35-0,75

## Port connectors male "superseal" watertight



Code	Desc.	N° Way
3170021440	52311	1
3170021450	52313	2
3170021465	52316	3
3170021475	52318	4
3170021485	52320	5
3170022420	52506	6



Code	Desc.	Sez. cable
3170022375	52497	1,0-1,5

- Watertight connector "Superseal" with secondary lock terminals step 1.5.
- Applications: sensors engine compartment.

- Male terminal step 1.5 insertable

## Plug for unused holes for plugs and sockets

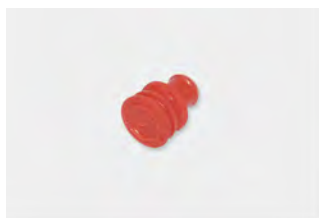

Code	Desc.	Material
3170022410	52504	SILICON



## Sealing ring for male and female terminals



Code	Desc.	Material
3170021415	52306	SILICON

## Sealing ring for male and female terminals



Code	Description
3170021417	Gommino giallo per filo d.est 1,8-2,4

## Port connectors females "superseal" watertight



Code	Desc.	N° Way
3170021435	52310	1
3170021445	52312	2
3170021455	52314	3
3170021470	52317	4
3170021480	52319	5
3170022415	52505	6



Code	Desc.	Sez. cable
3170022370	52496	1,0-1,5

- Watertight connector "Superseal" with secondary lock terminals step 1.5.
- 2-way female.

- Female terminal step 1.5 insertable

## Port connectors male "series 280" watertight



- Applications: engine compartment.
- 2-way male.



- Terminal male "series 280" insertable

Code	Desc.	N° Way
3170021495	52322	1
3170021505	52324	2
3170021515	52326	3

Code	Desc.	Sez. cable
3170021425	52308	1,0-2,5

## Sealing ring for male and female terminals



Code	Desc.	Material
3170021430	52309	SILICON

## Port connectors female "series 280" watertight



- 2 way female.



Code	Desc.	N° Way
3170021490	52321	1
3170021500	52323	2
3170021510	52325	3

Code	Desc.	Sez. cable
3170021420	52307	2 - 3

## Port connector male "econoseal" watertight



- Connectors for Iveco.
- Applications: sensors.



- Terminal male "econoseal" insertable

Code	Desc.	N° Way
3170015795	52121	2

Code	Sez. cable
3170021795-52382	0,5-1,5

## Port connector females "econoseal" watertight



- Connector for Iveco.



- Female terminal "econoseal" insertable

Code	Desc.	N° Way
3170015796	52122	2

Code	Sez. cable
3170021800-52383	0,5-1,5

## Hood 2-way



Code	Description	N° Way
3170022035	52430-2 way headset x connect.	2
3170022060	52435-3 way headset x connect.	3
3170022430	52508-4 way headset x connect.	4
3170022435	52509-5 way headset x connect.	5
3170022070	52437-7 way headset x connect.	7

## Port connectors female junior timer



Code	Desc.	N° Way
3170022310	52484	2
3170022330	52488	3
3170022335	52489	4
3170022340	52490	5
3170022345	52491	6
3170022350	52492	7



Code	Desc.	Sez. cable
3170022300	52482	0,5-1,5

- Applications: electronic fuel injection, to sensors and injectors.

- Terminale femmina "junior timer" inseribili

## Port Connector male "power timer"



Code	Desc.	N° Way
3170022355	52493	2



Code	Desc.	Sez. cable
3170022360	52494	0,5-1,0

- Terminal male "power timer" insertable

## Port Connector male "junior power timer"

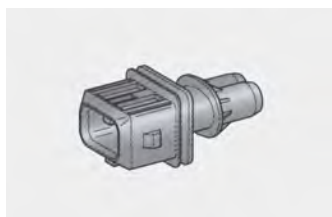

Code	Desc.	N° Way
3170025770	52707	2

- Application: for sensors and injectors.



Code	Desc.	Sez. cable
3170025740	52704	0,5-1,0

- Male terminal inserted jpt

## Seal rubber for terminals jpt



Code	Desc.	Color
3170025760	52706	HEAVENLY

## Circular Connectors DIN 1.5 for lights VI



- Circular Connectors DIN 1,5 -7 WAYS
- In the kit, consisting of 1 circular connector, 7 rubbers, 7 terminals and 1 corrazza straight + 90 °
- Mounted on Stralis

Code	Description	Content
3170026480	Kit conn.circ. DIN 1,5	1 circular connector 1 corrazza straight +90° 7 terminals 7 rubbers

Spare Parts	
Accessories	Code
Female terminal sez.0,8-1,5 mm <sup>2</sup>	3170026482
Red rubber 2.8-3.3	3170021415

## Circular connectors SICMA FCI for lights Iveco Daily 8-Way



- Circular Connectors SICMA FCI 8 WAYS
- To Iveco Daily 6-front lights
- In the kit, consisting of 1 circular connector, 6 gray rubbers for Sicma 1.5 mm and 2 blue rubbers for Sicma 2.8, 6 female terminals Sicma 1.5 sez.0,35-0,75 mm and 2 terminals female Sicma 2.8 sez.0,35-0,75 mm.

Code	Description	Content
3170026485	Kit conn. Sicma FCI 8 ways	1 Connector 8 terminals 6+2 8 rubbers 6+2

Spare Parts	
Accessories	Code
Grey rubber for Sicma 1,5 mm	3170026487
Blue rubber for Sicma 2,8 mm	3170022305
Female terminal Sicma 1,5 sez. 0,35-0,75 mm2	3170022595
Female terminal Sicma 2,8 sez. 0,35-0,75 mm2	3170026490

## Circular connectors for lights VI-3 Ways



- Circular Connectors 3 way
- To Iveco Eurocargo license plate lights
- In the kit, consisting of 1 circular connector, 3 red rubbers 2.8-3.3 mm, 3 female terminals sez.1-2,5 mm.

Code	Description	Content
3170026495	Kit conn. circ.3 ways	1 circular connector 3 terminals 3 rubbers

Spare Parts	
Accessories	Code
Female terminal sez.1-2,5 mm	3170026500
Red rubber 2.8-3.3	3170021415

## Circular connectors for lights VI-10 Ways

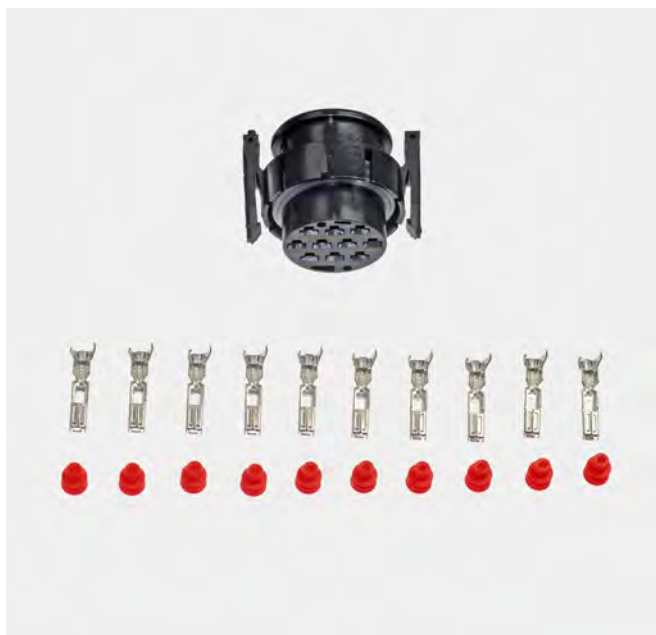

- Circular Connectors 10 way
- To Iveco Eurocargo rear lights
- In the kit, consisting of 1 circular connector, 10 red rubbers 2.8-3.3 mm, 10 female terminals sez.1-2,5 mm.

3

Code	Description	Content
3170026505	Kit conn .10 ways for headlights	1 circular connector 10 terminals 10 rubbers

Spare Parts	
Accessories	Code
Female terminal sez.1-2,5 mm	3170026500
Red rubber 2.8-3.3	3170021415

## MCP connectors for fitters 7 poles from 1.5 to 2.8

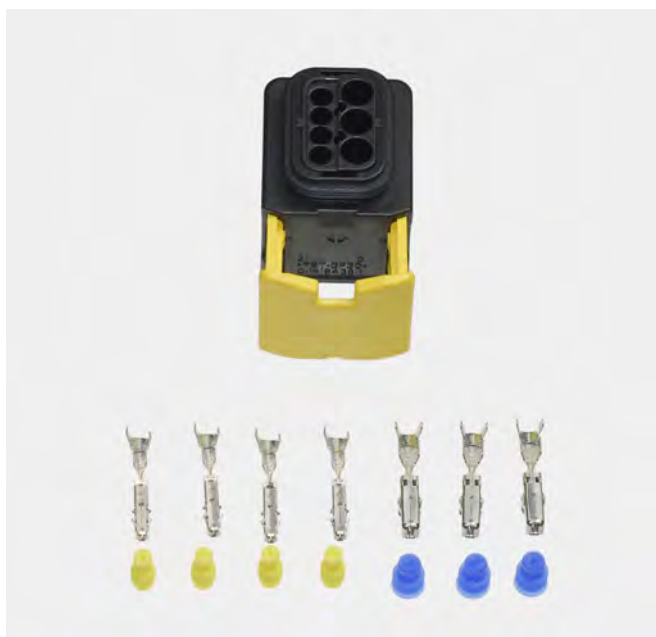

- Connectors 7-pole female port
- In the kit, consisting of 1 connector, 4 blue rubbers 1,2-2.1, 3 yellow rubbers MQS 1.10-1,30, 4 MCP female terminals sez.0,8-1,5 1.5 mm, 3 MCP female terminals sez.1-2,5 2.8 mm, 1 corrazza 90°
- Mercedes Euro 6 rear-Volvo-Daf-Scania.

Code	Description	Content
3170026510	Kit conn. MCP 7 poles	1 connector 7 female terminals 4+3 7 rubbers 4+3 1 corrazza 90°

Spare Parts	
Accessories	Code
Blue rubber 1,2-2.1	3170025760
Yellow rubber MQS 1.10-1,30	3170026512
Female terminal MCP 1,5 sez.0,8-1,5 mm2	3170026514
Female terminal MCP 2,8 sez.1-2,5 mm2	3170026516



## MCP connectors 1.5 for fitters 8 poles



- Connectors 8 poles female port Series MCP 1.5
- In the kit, consisting of 1 connector, 8 MQS yellow rubbers 1:10 to 1:30, 8 MCP 1.5 female terminals sez. 0,8-1,5 mm, 1 corrazza 90°
- Mercedes-Volvo-Daf-Scania.

3

Code	Description	Content
3170026520	Kit conn. MCP 1,5 8 poles	1 connector 8 terminals 8 rubbers 1 corrazza 90°

Spare Parts	
Accessories	Code
Yellow rubber MQS 1.10-1,30	3170026512
Female terminal MCP 1,5 sez.0,8-1,5 mm2	3170026514

## Rubber rear pipe with plastic ring for cargo. Mod.1



- Pipette rubber seal.
- Threaded ring for maximum grip on the lantern.
- Complete with steel washer inner sealing.
- **Adaptable to our codes: 428 00 00200 – 428 00 00190.**
- Shares and dimensions in the drawing.

Code	Description
4280002100	250-PIPA MODELLO 1

## Rubber rear pipe with plastic ring for cargo. Mod.2

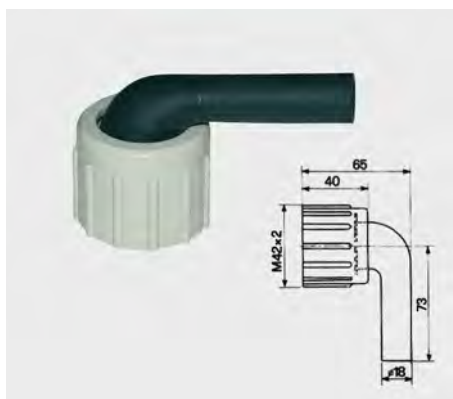

- Pipette rubber seal.
- Threaded ring for maximum grip on the lantern.
- Complete with steel washer inner sealing.
- **Adaptable to our codes: 428 00 00130 to 428 00 00140.**
- Shares and dimensions in the drawing.

Code	Description
4280002150	260-PIPAE MODEL 2

## Rubber rear pipe with plastic ring for cargo. Mod.3



- Pipette rubber seal.
- Threaded ring for maximum grip on the lantern.
- Complete with steel washer inner sealing.
- **Adaptable to our codes: 428 00 00150.**
- Shares and dimensions in the drawing.

Code	Description
4280002200	270-PIPA MODELLO 3

## Rubber rear pipe with plastic ring for cargo. Mod.4



- Pipette rubber seal.
- Threaded ring for maximum grip on the lantern.
- Complete with steel washer inner sealing.
- **Adaptable to our codes: 428 00 00230 – 428 00 00240.**
- Shares and dimensions in the drawing.

Code	Description
4280002250	280-PIPA MODELLO 4

## Rubber rear pipe with plastic ring for cargo. Mod.5



- Pipette rubber seal.
- Threaded ring for maximum grip on the lantern.
- Complete with steel washer inner sealing.
- **Adaptable to our codes: 428 00 00460 – 428 00 00470.**
- Shares and dimensions in the drawing.

Code	Description
4280002300	290-PIPA MODELLO 5

## Connectors for various applications not sealed FIAT Group



- For resistance FIAT group.

Code	Description	Content
3170026525	Kit conn. Fiat resistance	1 connector 5 terminals

Spare Parts		
Article	Code	Description
Spare terminal	3170022520	52526- fem. term. 1-2,5 mm2

## Connectors for various applications not sealed FIAT Group



- For resistance heating FIAT Group.

Code	Description	Content
3170026530	Kit conn. res. heat. Fiat group	1 connector 5 terminals

Spare Parts		
Article	Code	Description
Spare terminal	3170026490	Female terminal Sicma 2,8 sez. 0,35-0,75 mm2

## Connectors resistance Grande Punto-Bravo



- For resistance FIAT Group latest cars.

Code	Description	Content
3170026532	Kit conn. res .heat. Fiat group Punto/Bravo	2 connectors grey+black 4 terminals

Spare Parts		
Article	Code	Description
Spare terminal	3170026492	Female terminal Sicma 4,8 sez. Standard time

## Connectors for control unit new Fiat Panda



- For control unit new Fiat Panda

Code	Description	Content
3170026535	Kit control unit new Panda	1 connector 10 terminals

Spare Parts		
Article	Code	Description
Spare terminal	3170026490	Female terminal Sicma 2,8 sez.
Spare terminal	3170022595	52541-fem. term. 1-1,5 mm2

## Connectors for Japanese cars alternators



- For Japanese cars alternators.

Code	Description	Content
3170026540	Kit conn. Japanese cars	1 connector 3 terminals 3 rubbers

Spare Parts	
Code	Description
3170025760	Blue rubbers 1,2-2.1
3170026542	Female terminal x 3170026540

## Connector Bosch MBK 2 ways

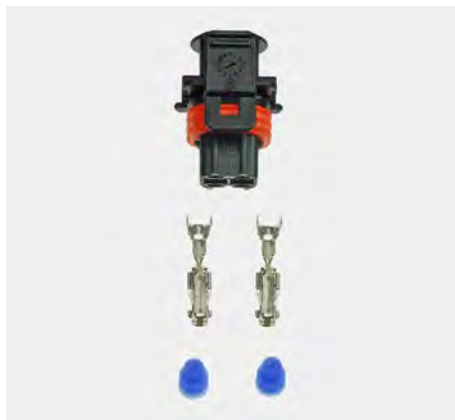

- Connector kit, composed of connector rubbers and terminals.
- For injection and common-rail

Code	Description	Content
3170026545	Kit conn. Bosch MBK 2 ways	1 connector 2 terminals 2 rubbers

Spare Parts	
Code	Description
3170025760	Blue rubbers 1,2-2.1
3170026547	Terminal MBK sez. 0,5-1 mm <sup>2</sup>

## Connector Bosch MBK 3 Ways

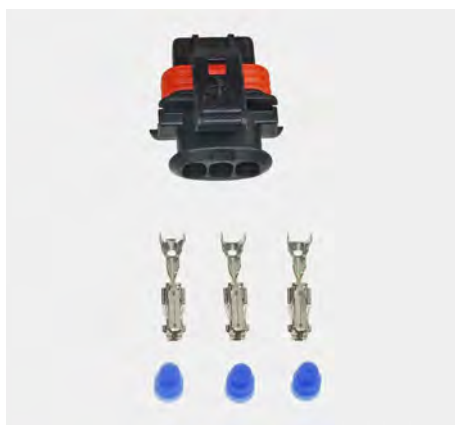

- Connector kit, composed of connector rubbers and terminals.
- For injection and common-rail.

Code	Description	Content
3170026550	A-Kit conn .Bosch MBK 3 ways	1 connector 3 terminals 3 rubbers

Spare Parts	
Code	Description
3170025760	Blue rubbers 1,2-2.1
3170026547	Terminals MBK sez. 0,5-1 mm <sup>2</sup>

## Connector Bosch MBK 3 Ways



- Connector kit, composed of connector rubbers and terminals.
- For injection and common-rail.

Code	Description	Content
3170026555	B-Kit conn. Bosch MBK 3 ways	1 connector 3 terminals 3 rubbers

Spare Parts	
Code	Description
3170025760	Blue rubbers 1,2-2.1
3170026547	Terminal MBK sez. 0,5-1 mm <sup>2</sup>

## Connector Bosch JPT 2 Ways



- Connector kit, composed of connector rubbers and terminals.
- For injection and common-rail

Code	Description	Content
3170026560	Kit conn. Bosch JPT 2 ways	1 connecteur 2 cosses 2 caoutchouc

Spare Parts	
Code	Description
3170025760	Blue rubbers 1,2-2.1
3170022300	Terminal JPT sez.0,5-1 mm <sup>2</sup>

### Connector Bosch JPT 3 Ways



- Connector kit, composed of connector rubbers and terminals.
- For injection and common-rail.

Code	Description	Content
3170026565	Kit conn. Bosch JPT 3 ways	1 connector 3 terminals 3 rubbers

Spare Parts	
Code	Description
3170025760	Blue rubbers 1,2-2.1
3170022300	Terminal JPT sez.0,5-1 mm <sup>2</sup>

### Connector Bosch JPT 4 Ways



- Connector kit, composed of connector rubbers and terminals.
- For injection and common-rail

Code	Description	Content
3170026570	Kit conn. Bosch JPT 4 ways	1 connector 4 terminals 4 rubbers

Spare Parts	
Code	Description
3170025760	Blue rubbers 1,2-2.1
3170022300	Terminal JPT sez.0,5-1 mm <sup>2</sup>

### Connectors for Injection Ford and Opel group 2 Ways



- Kit sealed connector for Ford and Opel group
- For injection and common-rail

Code	Description	Content
3170026575	Kit conn. Ford-Opel injection 2 ways	1 connector 2 terminals 2 rubbers

Spare Parts	
Code	Description
3170026512	Yellow rubbers MQS 1.10-1,30
3170022275	Female terminal Micro timer sez.0,5-1 mm <sup>2</sup>

### Connectors for injection BMW-Mercedes and group VW Audi Seat Skoda Porsche 3 Ways



- Kit sealed connector for BMW and Mercedes group
- For injection and common-rail

Code	Description	Content
3170026580	Kit conn. injection VW group	1 connector 3 terminals 3 rubbers

Spare Parts	
Code	Description
3170025760	Blue rubbers 1,2-2.1
3170026582	Female terminal Micro timer sez.0,5-1 mm <sup>2</sup>

## Connectors for injection common-rail Nissan 3 Ways



- Kit sealed connector for Nissan group
- Common-rail system and injection.

Code	Description	Content
3170026585	1/Kit conn. Common -rail Nissan 3 ways	1 connector 3 terminals 3 rubbers

Spare Parts	
Code	Description
3170026487	Grey rubber for Sicma 1,5 mm
3170026587	Female terminal Econoseal J sez.0,3-0,8 mm2

## Connectors for injection common-rail Nissan 3 Ways



- Kit sealed connector for Nissan group
- Common-rail system and injection.

Code	Description	Content
3170026590	2/Kit con. Common-rail Nissan 3 ways	1 connector 3 terminals 3 rubbers

Spare Parts	
Code	Description
3170026487	Grey rubber for Sicma 1,5 mm
3170026592	Male terminal Econoseal J sez.0,3-0,8 mm

## Connectors for injection common-rail Renault-Peugeot-Citroen-Ford-Opel group 3 Ways



- Kit sealed connector for various automotive groups
- Common-rail system and injection.

Code	Description	Content
3170026595	Kit conn. Common-rail Renault-Opel-Ford-Peugeot-Citroen	1 connector 3 terminals

Spare Parts	
Code	Description
3170022595	Female terminal Sicma 1,5 sez.0,35-0,75 mm