

## Kit timing: introduction

- The kits timing should always be identified taking into account the engine code indicated on the registration certificate of the vehicle.

### Kit timing engine Alfa Romeo 105 1.6 eco hp gasoline



- The kit consists of 2 aluminum caps.
- Each cap is marked with the number of the cylinder is positioned and where it should be placed at the suction side "A" or drain "S".

130A-130S (2° & 3° cilindro):

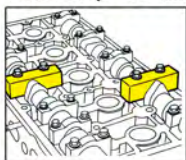

Code	Desc.
4770002550	255

8

### Kit caps Fiat, Alfa, Lancia



- Updated version to 2001.
- Aluminum caps with marking for easy identification of the application.
- Each cap is marked with the n° of the cylinder should be positioned and where it should be placed in correspondence of the suction side "A" or the drain "D".
- The kit contains 25 caps in aluminum. Particularly suitable for workshops and car dealerships.

Code	Desc.
4770002540	254

ART.	CAMME	CIL. N°	MOTORE	N° PEZZI	ART.	CAMME	CIL. N°	MOTORE	N° PEZZI
00	A	2	FIAT Bravo/Bravo-Lancia 110 1.4 12V	1	70	A	3	FIAT Bravo/Bravo/Marea 2.0 20V	2
10	A	3	LANCIA K S C. Z.0 20V MOT. VIS '96	2	70	S	2		
10	S	2			80	A	2	FIAT Barchetta/Coupe 1800 16V con variatore	2
20	A	1	ALFA 3.0 V6 24V	2	80	S	3		
20	S	1			90	A	2	ALFA 145/146 1400 16V - 1600 16V	2
21	A	6		2	90	S	3	(Motore Step-At)	
21	S	4			100	A	2	ALFA 156 1600 16V - ALFA 145/146 1400 e 1600	2
40	A	3	LANCIA SC. PRECEDENTE-AL '96	2	100	S	3	ALFA 155 1600 16V	
40	S	2			105	A	2	ALFA 156 1800-2000 16V - Spider e Qv TS 2000	2
50	A	2	FIAT Bravo/Bravo/Marea - LANCIA 1800 16V 115CV	2	105	S	3	155 TS 1800	
50	S	3	Delta/Dedra 1800 16V 1860 847/C2		120	A	3	FIAT 2.0 Turbo - LANCIA 2.0 Turbo	2
60	A	2	FIAT Coupe - LANCIA - ALFA 1800 16V 130CV	2	120	S	2		
60	S	3	ALFA 155						

A= Aspirazione S= Scarico

## Kit for the timing of the engine of the new engines 1.9-2.4 JTD Multijet 140hp-175CV, Alfa, Fiat, Lancia

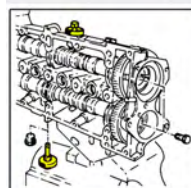

- Models: Alfa 145, 146, 147, 156, 1.9 JTD 16v., 156 2.4 JTD 20v., 166 2.4 JTD 20v., Gt 2.4 jtd 20v. Fiat Punto, Grande Punto, Brava / Bravo Marea Weekend, Stilo, Doblo / Cargo, Multipla 1.9 JTD 16v. Lancia Lybra 1.9 JTD 16v., Lybra 2.4 JTD 20v., Thesys 2.4 JTD 20v.
- Engines: 1.9-2.4 JTD
- Engine codes: 323.02,371.01, 182B4.000, 182B9.000, 186A6.000, 188A2.000, 188A7.000, 188B2.000, 192A1.000, 192A3.000, 937A2.000, 939A1.000, 192A5.000, 192B1.000, 937A5.000, 939A2.000, 325.01, 342.02,362.02, 185A6.000, 841C.000, 841G.000,939A3.000, 940A3.000, 940A4.000.
- With instructions included.

Code	Desc.
4770005600	660

## Kit timing engine Alfa Romeo 2.0 JTS 165 hp

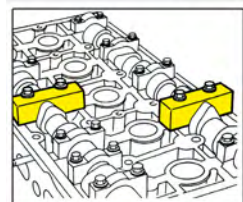
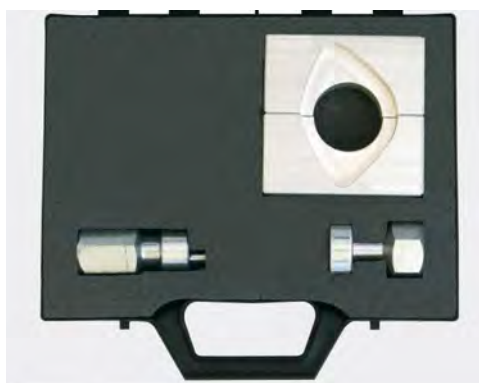

- Cap 150A-150S (cylinders: 2nd & 3rd).
- Models: 2.0 gt jts.
- Engine codes: 937A1.000, 932A2.000.
- With instructions included.

Code	Desc.
4770005570	654

## Tensioner eccentric for Alfa Romeo



- New cam tensioner for tensioning roller mounted on the new Alfa Romeo Alfa 156-166-147 see gasoline.
- Indispensable when replacing timing belt and timing.
- With instructions included.

Code	Desc.
4770002560	256

## Kit timing engines BMW 320d, 330d, 530d, 730d Diesel

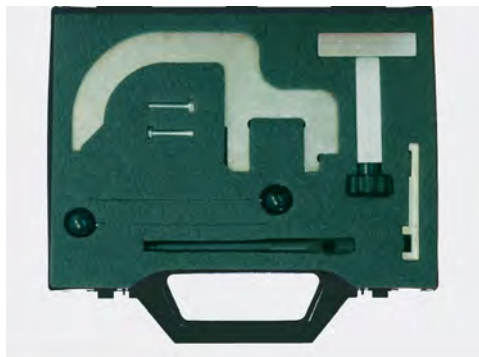

- Models: 320D, 330D (E46), 520D, 530D (E39) (98-04), 730D (E38).
- suitable for: Land Rover Freelander (TD4) MG-Rover 75 2.0 CDT / cdti (99-04) -04).
- Engine codes: M47, M57 (chain), 30 6D 2.
- With instructions included.

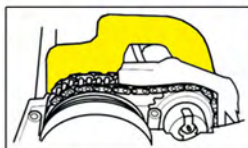

Code	Desc.
4770002990	

## Complete kit for the timing of the petrol engines BMW 1.8 - 2.0 N42 & N46 (chain)

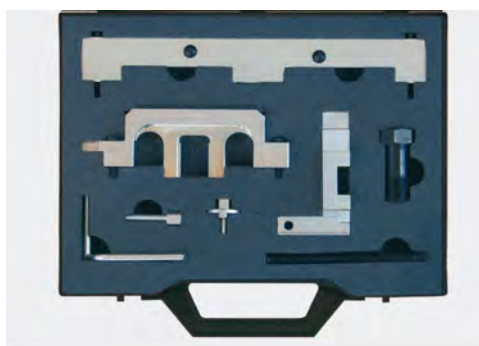

- Models: 118i - 120I, 316i - 318I, 316TI - 318 TI.
- Engines: 1.8, 2.0.
- Engine codes: B18, b20.
- With instructions included.

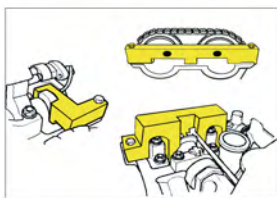

Code	Desc.
4770005575	655

## Complete kit for the timing of the petrol engines BMW 1.6 N40, N45 & N45 (belt)

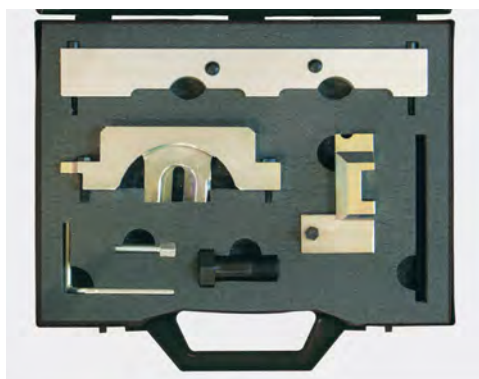

- Models: 116i. E81 / E87, 316i. E46 / E90, 316CI. E46, 316TI. E46.
- Engines: 1.6
- Engine codes: B16A B40, B16 to N45, N45 B16 AC.
- With instructions included.

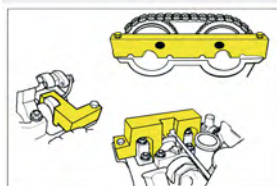

Code	Desc.
4770005580	656

## Complete kit for the timing of the BMW diesel engines 2.0



- Models: 118D. E81 / 87 (06-09) 120D. E81 / 82/87 (06- 09) 123D. E81 / 82/87 (07-09) 318D. E90 / 91 (07-09) 320D. E90 / 91/92 (05-09) 520D. E60 / 61 (06-08) X3. 2.0D. E83 (07-09).
- Engines: N47 & N47S:
- Engine codes: D20A, D20.
- With instructions included.

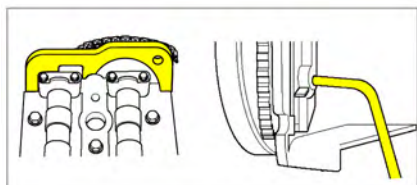

Code	Desc.
4770005585	657

## Injection pump pulley puller BMW engines



- Models: M47 (only extractor).
- M47TU (extractor & centering bushing).
- M57 (puller & centering sleeve).
- M57TU (puller & centering sleeve).
- Including: centering sleeve, measuring m 40x1,5 mm. Centering bushing, measure m 42x1,5 mm.
- **Caution: during the removal operation of the injection pump always use together with the centering bushings also the extractor.**

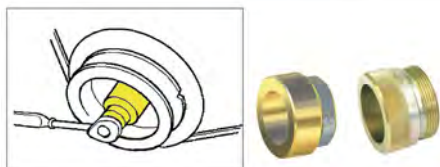

Code	Desc.
4770005590	658

## Injection pump pulley puller BMW engines



Code	Desc.
4770005595	659

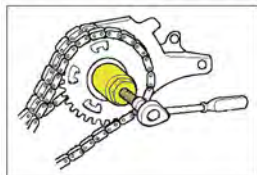

## Kit timing MINI - PSA 1.4-1.6 16v N12 & N14

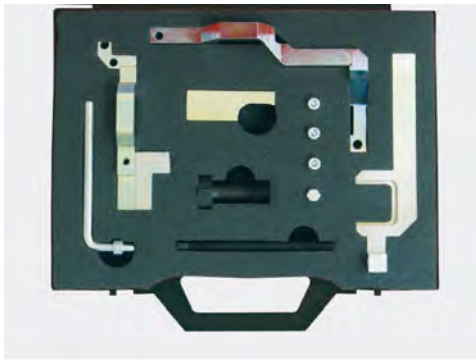

- Models: Mini One, Mini Cooper, Mini Cooper S, Citroen C4 - C4 Picasso, Peugeot 207, Peugeot 308.
- Engines: 1.4 - 1.6. petrol
- Engine codes: R55 - R56, EP3 - EP6, EP6DT / DTS.
- With instructions included.

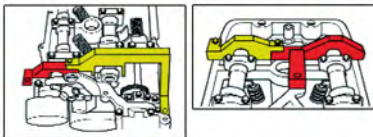

Code	Desc.
4770005630	666

## Kit 4 pcs for the timing of the engine Fiat Punto 1.2 and 1.4 16V



- Models: Punto, Bravo, Brava, Marea, Palio Weekend, Stilo. Engine: 1.2 16v, 1.4 16v.
- Engine codes: 176B9.000, 182B2.000, 188A5.000, 843A1.000.
- Complete kit for the timing of engines 1.2 16V tensioner complete with 1/4 to be used in conjunction with a normal ratchet 1/4 see 488 00 33810-415 allowing you to do this in absolute tranquility.
- The kit also comes with eccentric tensioner for tensioning roller motor of grupo fiat except 1.2 16V engines.
- **With illustrations for use.**

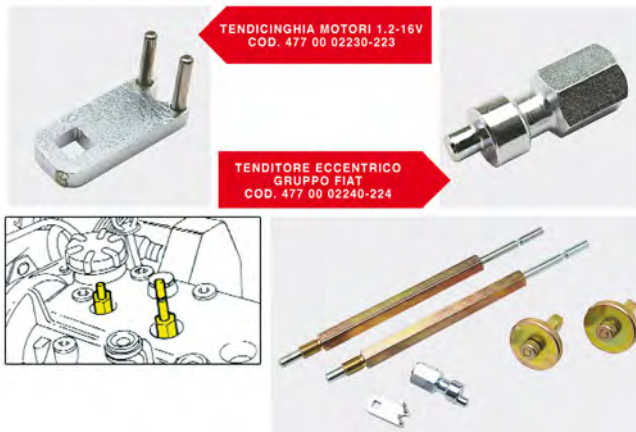

Code	Description
4770002220	222 Kit
4770002230	223 - 1.2 16V engines Tensioner

## Piece for timing engine Fiat 1.4 16v



- For engines not multi-air.
- The block must work in conjunction with the kit 4770002220
- Factory authorized and not



Code	Desc.	OEM
4770002221	222/1	2 000 015 800

## Kit timing petrol Fiat 1.6 16v



- Models: Bravo, Brava, Marea, Palio Weekend, Stilo, Multipla.
- Engines: 1.616v.bipower, BluPower
- Engine codes: 178B3.000, 182A4.000, 182A6.000, 182B6.000, 186A4.000, 182B6.000, 186A3.000.
- Tensioner double pin M8 and M10.

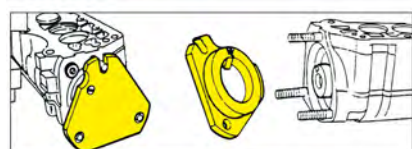

Code	Desc.
4770002571	257/1

## Kit timing camshaft and crankshaft of the Fiat Ducato 2.3 JTD Diesel



- Models: Ducato, Iveco Daily.
- Engine: 2.3 JTD.
- Engine code: F1AE048IC, F1CE048ID, F1AE048IA, F1AE048IB, F1CE0481A.
- With instructions included.

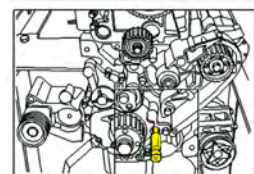

Code	Desc.
4770002970	297

## Kit phasing new petrol engines Fiat 1.2 8v, Fiat 1.4 8v Fire Evo 2



- Models: the Fiat Idea, Punto, Grande Punto, Stilo, Panda, 500, Bravo, New Point, New Panda Lancia Ypsilon, Musa.
- Engines: 1400 fire evo 2, 1400 16v. 95 hp. Starjet, 1400 16v. 100 hp. Starjet, 1400 16v. 90 hp. Starjet, 1400 16v. 120 hp. t-jet, 1400 16v. 150 hp. t-jet. -jet, bi-fuelgpl 1.4, 1.4 Natural Power methane.
- Engine codes: 350A1.000, 169A4.000, 199A4.000
- With instructions included.

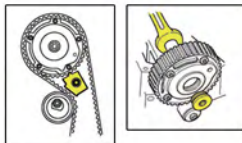

Code	Desc.
4770004690	329

## Tools timing crankshaft and camshaft of the new engines Fiat, Lancia, Opel, Suzuki 1.3 Multijet 16V



- Models: Punto, Panda, Idea, Doblo, Doblo Cargo, Stilo, Ypsilon, Musa, Corsa, Agila, Meriva, Combo tour, Ignis, Swift, Vagon R +.
- Engines: 1.3 multijet, 1.3 cdti, 1.3 ddis.
- Engine codes: 188A8.000, 188A9.000, 199B1.000, 199B2.000, 199A2.000, 199A3.000, 169A1.000, 199A9.000, 223A9.000.
- With instructions included.

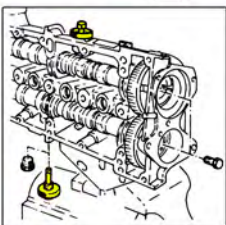

Code	Desc.
4770002910	291

## Timing tool new petrol engines Fiat Panda 1.2

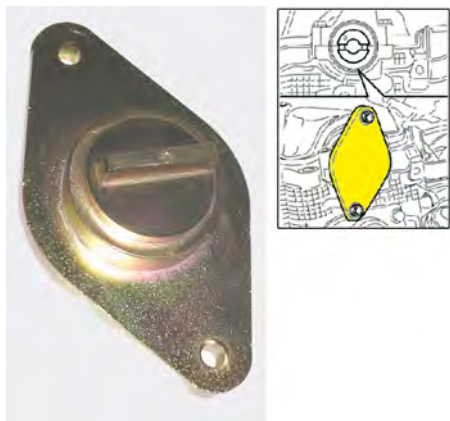

- Models: Point, New Point, New Panda.
- Engines: 1.2 8v.
- Engine codes: 188 A4.00.

Code	Desc.
4770003020	302

## Kit specific timing for commercial vehicles with engines 2.2-2.3-3.0 MJ

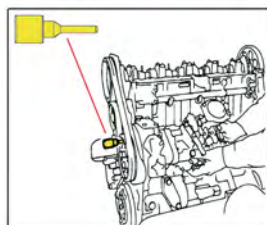

- Models: the new Fiat Ducato, Iveco Daily, Van Ford Transit, Peugeot Boxer, Citroen Jumper.
- Engines: 2.2 JTD, 2.3 JTD, 3.0 JTD
- Engine codes: 4HV, F1AE0481D, F1AE0481N, F1CE0481D, F1CE0481F, F1CE0441F, F1CE0481H, F1AE0481R, F1AE0481G, F1AE0481F, F1AE0481H, P8FA, QVFA, QWFA, P8FB, SRFA, PGFA, PGFB, SRFB, SRFC, SRFD, SRFE, P22DTE (4HV ), P22DTE (4HU), 4HV (P22DTE), 4HU (P22DTE).
- With instructions included.

Code	Desc.
4770005605	661

## Kit timing petrol Fiat & Alfa 1.4 MultiAir

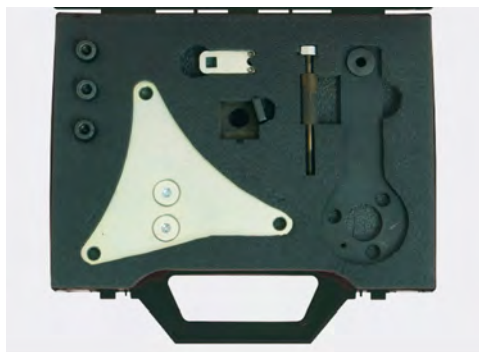

- Models: Alfa Romeo Mito, Alfa Romeo Mito green cloverleaf
- Engines: 1.4 Multiair 16v 105cv, 1.4 Multiair Turbo 16v 135cv 170cv &
- Models: Alfa Romeo Giulietta
- Engines: 1.4 Multiair Turbo 16v 170cv.
- Models: Fiat Punto Evo
- Engines: 1.4 multiair start & stop 105cv 16v, 1.4 16v turbo multiair start & stop 135cv.
- Models: Fiat Bravo
- Engines: 1.4 Multiair Turbo 16v 140hp
- Models: Fiat Abarth Punto Evo
- Engines: 1.4 Multiair Turbo 16v 165cv
- Models: Fiat 500
- Engine: 1.4 16v 102cv multiair
- Engine codes: 955A6.000, 955A2.000, 955A7.000, 940A2.000, 955A8.000
- With instructions included.

Code	Desc.
4770005610	662

## Tensioner bearing Fiat Punto, petrol



Code	Desc.
4770002230	223



## Tool top dead center



- Tool control T.D.C. first piston cylinder for positioning the sensor support plate (static electronic ignition) to use with dial gauge with 10mm stroke engine 1581-16v  $\varnothing$  14x 1.25.
- Fiat Bravo-Brava engine 1581-16v.
- For latest models gr. Fiat  $\varnothing$ 12x1,2.

Code	Desc.	$\varnothing$ x filetto
4770002180	218-14x1,25	14x1,25
4770002182	218-12x1,25	12x1,25

## Centesimal comparator



- Stroke 0-10 mm for use with tool contr. T.D.C.
- Diameter 58 mm

Code	Desc.
4640000200	165

8

## Tool captures flying Fiat 1.8 for engines Gasoline and Diesel



- Engines: 1.8 petrol & diesel 1.6, 1.9, 2.0, 2.4.

Code	Desc.
4770005615	663

## Kit timing gasoline engines Ford (full key lock pulley)



- Models: Ford: Fiesta, Focus, Puma Mazda: 121 Volvo: S40, V50 gasoline
- Engines: 1.2, 1.4, 1.6, 1.7 16V. 1.8 & 2.0 16V belt. Belt & Chain 1.4, 1.6 & 16V.Focus Mazda 121
- Engine codes: FUJA, FUJB, FXJA, FXJB, FYJA, FYJB, F8JA, F8JB, F8JV, M7JA, M7JB, DHA, DHB, DHC, DHD, DHE, DHF, DHG, FHA, FHD, FHE, FHF, L1T, L1V, L1E, L1G, L1H, L1K, L1W, RDA, RDB, RKC, RQB, RQC FXDA / C, FXDB / D, Fyda / C, FYDB / D, FYDH, HWDA.
- With instructions included.

Code	Desc.
4770005620	664

## Kit timing Ford diesel engines: 2.0, 2.2, 2.4 16v Duratorq TDCI

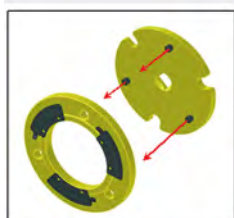

- Models: Focus C-Max, S-Max, Mondeo, Transit, New Galaxy
- Engines: 2.0, 2.2, 2.4 Duratorq TDCI 16V
- Engine codes: FMBA / B, D5BA, ABFA, D3FA, D6BA, HJBA / B, F3FA, D2FA, D4FA, F4FA, F1FA, Dofa, QJBA, QJBB, FXFA, H9FA.
- With instructions included.

Code	Desc.
4770004730	

## Complete kit for the commissioning phase and replacement of the timing belt engine Ford 1.6 Ti-VCT

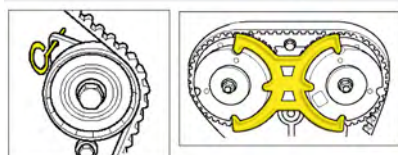

- Models: Fiesta, Focus, C-Max
- Engines: 1.6 TI-VCT, 2.0 TDCI
- Engine codes: HXDA, HXJA, SIDA, G6DA, G6DB, G6DC
- With instructions included.

Code	Desc.
4770005625	665

## Capture tool flywheel Ford engines

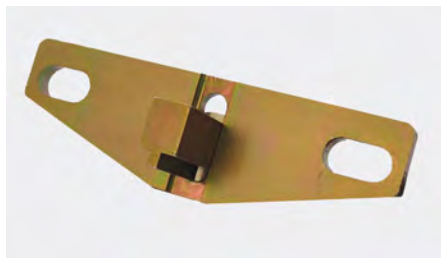

Code	Desc.
4770002940	294

## Pin timing Ford Zetec E



- Timing pulley locking pin for new engines and Ford zetec gasoline.
- Zetec engines and are currently mounted on models 16v Ford Fiesta / Focus / Mondeo petrol.
- For all repair shops.

Code	Desc.
4770002520	252

## Pin timing Ford TDCI



- Timing pulley locking pin for new Ford common rail diesel engines.
- The engines are currently fitted on models Ford Focus / Mondeo / td Galaxy us.
- For all repair shops.

Code	Desc.
4770002530	253 + TD CI

## Complete kit for correct positioning camshafts during operations belt replacement diesel engine Opel 2.0 TDI, DTL, DTH, DTX.

- Models: Opel Vauxhall Astra, Astra Van, Zafira, Vectra, Omega, Sintra, Frontera, Signum Saab: 9-3, 9-5 (98-04)
- Engines: Opel: 2.0 & 2.2 Saab: 2.2 with code: D223L
- Engine codes: X20DTL, X20D.
- With instructions included.

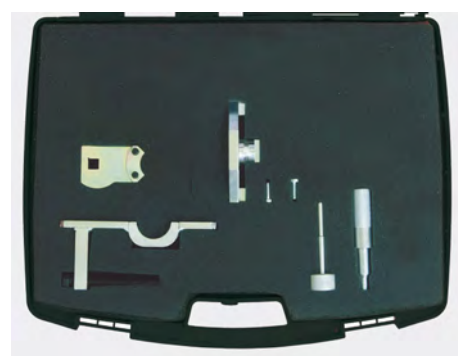

Code	Desc.
4770005635	667

## Tools timings Opel petrol engines

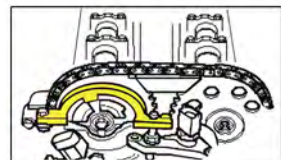

- Models: Corsa, Agila, Astra, Meriva.
- Engine: 1.0 12v., 1.0 16v., 1.2 16v., 1.4 16v. (chain).
- Engine codes: X10XE, Z10XE, Z10XEP, X12XE, Z12XE, Z14XEP, Z12XEP, Z14XEL
- With instructions included.

Code	Desc.
4770005640	668

## Kit for the timing of the engine Opel / Vauxhall from 1.4 up to 2.2 EcoTec 16v DOHC



- Models: Corsa C, Combo, Tigra, Tigra B, Meriva, Astra F, Geh, Speedster / VX220, AEB Zafira, Vectra B EC, Signum, Omega B, Sintra, Frontera AEB.
- Engines: 1.4 16V, 1.6 16V, 1.8 16V, 2.0 16V, 2.2 16V.
- Engine codes: X14XE, Z14XE, X16SEJ, X16XE, X16XEL, Y16XE, Z16XE, Z16YNG, C18XEL, X18XE, X18XE1, Z18XE, Z18XEL, C20SEL, C20XE, X20XEV, Z20LEH, Z20LEL, Z20LER, Z20LET, X22SE, X22XE, Y22SE, Y22XE, Z22XE
- With instructions included.

Code	Desc.
4770005645	669

## Locking pin for flywheel engines Opel 1.3 CDI



- Engines: 1.3 cdti
- Pin already in the kit timing MJ 4770002910-291.

Code	Desc.
4770002911	291/O

## Kit timing crankshaft and camshaft engines GM, Opel, Chevrolet 2.0.

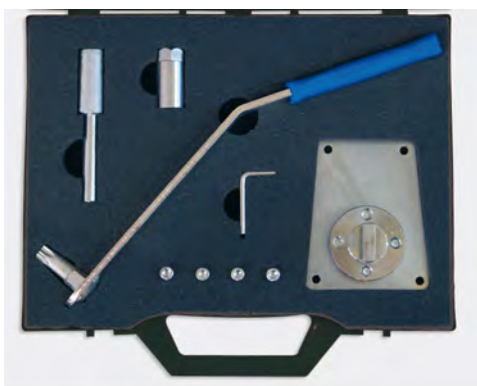

- Models: Opel Antara
- Engines: 2.0 tdcI Daewoo & Chevrolet: Epica, Captiva, Lacetti, Lacetti, Evanda
- Engine: 2.0 D engine VCDII: Z20DMH, Z20DM, RA420, Z20S1
- New updated version that includes the key lock flywheel and crankshaft pulley blocks.
- With instructions included

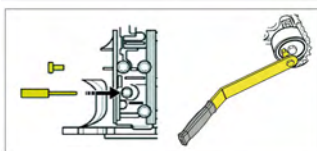

Code	Desc.
4770005655	671

## Kit timing engine Opel 1.6, 1.8 16v gasoline Twinport. (belt)

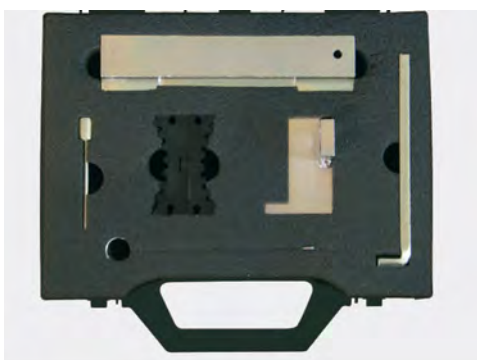

- Models: Corsa-BCD, Agila, GH Astra, Meriva, Zafira-B, Vectra-C, Signum, Insignia.
- Engines: 1.6 16V, 1.8 16V
- Engine codes: Z16XEP, Z16XE1, Z16LET, Z16LER, Z16LEL, Z18XER, A18XER / 2HO - FIAT / ALFAROMEO 939A4.000.
- With instructions included.

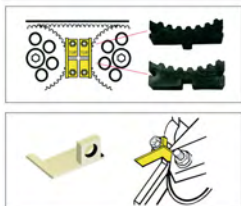

Code	Desc.
4770005650	670

## Tool kit for the timing of the diesel Peugeot



- Models: Citroën Xsara, Xsara Picasso, C2, C3, C4, C5, C8, Xantia, Evasion, Synergie Evasion, Berlingo, Dispatch, Jumpy Dispatch, Relay, Relay Jumper Peugeot: 107, 206, 207, 306, 307, 308, 406, 406 coupe, 407 607, 807, Expert, Partner, Boxer, Ranch Fiat Ulysse, Scudo, Ducato (reference jtd) Volvo S40 / V50 Ford: Focus, Focus C max, Fiesta, Fusion
- Engines: 1.4, 1.6, 2.0, 2.0 d, 2.0 tdcI, 2.2 HDi, 1.4 HDi, 1.6 HDi, 1.6 liter Duratorq TDCi, 1.6 d
- Codes: DV4TD (8HW / 8HX / 8HZ), DV4TED4 (8HV / 8HY), DV6TED4 (9HX / 9HY / 9HZ), DW10T D (RHY), DW10ATED / L3 / L4 (RHS / RHW / RHZ), DW10BTED4 / LB (RHR / RHX), DW10UTD (RHN), DW12ATED (4HW / 4HX), DW12UTED (4HY), D4204T / 2 G6D4, G6DB, G6DC.
- With instructions included.

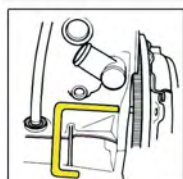

Code	Desc.
4770005665	673

## Complete kit for the timing of the Peugeot petrol engines

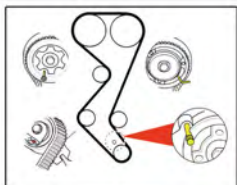

- Models: Citroen: C5, AX, AX, Saxo, C15, BX, ZX, Berlingo, Xsara / Picasso, Visa, Xantia, XM, Synergie, Relay / Jumper, Eevasion / Synergie, Dispatch / Jumpy, C8 Peugeot: 106, 205, 206, 305, 306, 307, 309, Partner, 405, 406 / Coupe, 605, 607, 806, 807, Boxer, Eexpert.
- Engines: 1.0, 1.1, 1.4, 1.6, 1.6 16V, 1.6 GTI, 1.6 18V, 1.8, 1.8 16V, 1.9, 2.0, 2.0 16V, the 2.0T, 2.0 HPI, 2.2 16V
- Engine codes: TU9-1.0, TU1-1.1, TU3-1.4, TU5JP- 1.6 (CDY / CDZ / HDY / KDX / KDY / KFW / KFX / KFZ / NFZ), TU5J4 / L3 (NFX / NFU), XU5 (B1E / B6D), XU9 (D6A / D6B), XU5 (BDY / BDZ / BFZ), XU7 (L6A / LFX / LFZ), XU9 (D6A / D6B / D6D / DDZ / DKZ / DFZ), XU10J2 (RFU / RGX / RGY / RFZ / RFX / RFW / RDC), XU7JP4 (LFY), XU9J4 (D6C), XU10J4 (FRY / RFV / R6E / RFS / RFT).
- With instructions included.

Code	Desc.
4770005670	674

## Kit for the timing of the PSA petrol and diesel engines

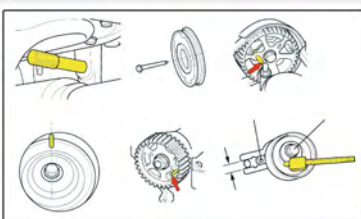

- Models: Ford: Fiesta, Fusion, Focus, Focus Cmax Citroen: Xsara, C2, C3, C4, C5, C8 Evasion Peugeot: 107, 206, 207, 306, 307, 308, Ranch, Expert, 406, 407, 607, 807 Volvo S40 / V50
- Engines: 1.4 -1.6 HDI, 1.6-liter Duratorq TDCi, 1.6 D, 1.8- 2.0 EW.
- Engine codes: DV4TD (8HW / 8HX / 8HZ), DV4TED4 (8HV / 8HY), DV6ATED4 (9HX / 9HY / 9HZ), F6JA, F6JB, F6JC, G8DA, G8DB, EW7J4 (6FZ), EW10J4 (RFN / RFR) EW10J4S (RFK), EW10-CVI (RLZ), EW12 (3FZ), D4164T
- With instructions included.

Code	Desc.
4770004700	330

## Complete kit for the timing and locking the flywheel engine Diesel 2.7 V6 (TDV6)

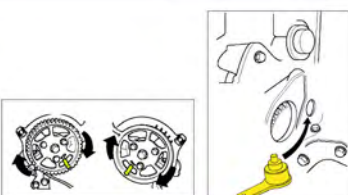

- Models: Land Rover Range Rover Sport, Discovery 3 Jaguar s-type, XJ series CITROEN: Peugeot C6: 4 07 / Coupe, 607
- Engine: 2.7 v6
- Codes engines: 276DT, DT17TED4 (UHZ) (TDV6).
- With instructions included.

Code	Desc.
4770005660	672

## Kit for the timing crankshaft engine Renault 16v gasoline + locking bracket pulley specific distribution for the 1.4 - 1.6 16v

- Models: Renault: Clio, Clio Sport, Megane, Scénic, Laguna, Espace. Nissan Note, Qashqai
- Engines: 1.4-1.616v, 1.816v, 2.016v
- Engine codes: K4J 712/713/750, 700/701/720/724/748 K4M, F4P 760, F4R 700/701/730/740/741/744/780.
- With instructions included.

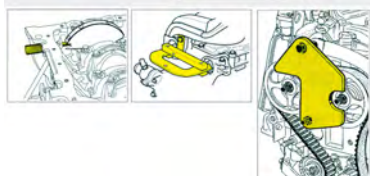

Code	Desc.
4770005675	675

## Kit commissioning phase crankshaft and camshaft, diesel engines Renault

- Models: Renault: Laguna, Espace, Master, Clio, Kangoo Nissan Micra, Interstar, Primastar, Qashqai.
- Engines: 1.5dCi,, 2.2dCi, 2.2 / 2.5DCI.
- Engine codes: G9T710 / 720, G9U, K9K since 2001, G9U 730, G9T 722/750, G9U 720/724/726/750/754.
- With instructions included.

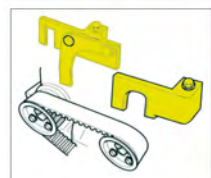
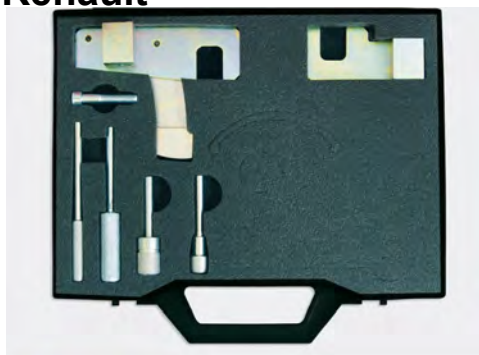

Code	Desc.
4770003030	303

## Kit commissioning phase crankshaft and camshaft, diesel engines Renault

- Modelli: Renault: Mégane/Scénic, Laguna, Trafic, Twingo, Clio, Kangoo. Nissan: Qashqai, Kubistar, Interstar. Volvo: S40 / V40.
- Motori: 1.9 td, 1,9, 1.9 dci, 1.2, 1.2 16V.
- Codici motore: F9Q 732, F9Q 718, F9Q 760, F9Q 732, F9Q 750, F9Q 754,4192Tt3/4, D7F700/701/703/710/730 (1995-06)D4F, 702/704/706/708/712/714/716/730 (2000- 06), D7F726, D4F712, F9Q, 772/774.
- Con istruzioni inserite.

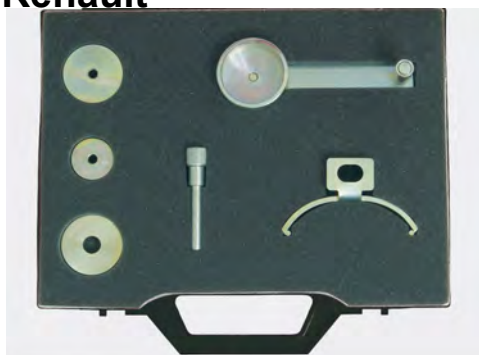

Code	Desc.
4770004710	331

## Kit commissioning phase crankshaft and camshaft, 1.5 diesel engines Renault and Renault petrol

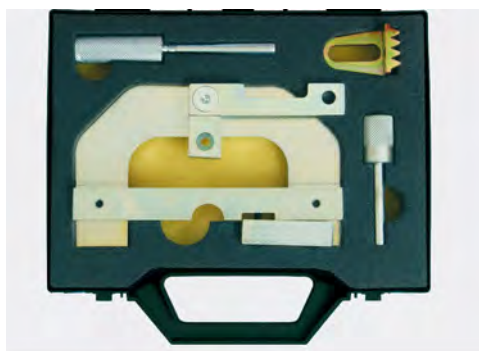

- Models: Renault: Clio, Clio Sport, Megane, Megane Scenic, VelSatis, Avantime, Kangoo, Laguna, Espace. Nissan Micra, Note, Qashqai.
- Engines: fuel: 1.4, 1.5 dCi, 1.6, 1.8, 2.0 16v.
- Engine codes: K4J / K4M, F4P / F4R, K9K since 2001.
- With instructions included.

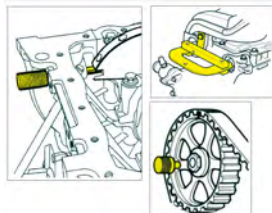

Code	Desc.
4770005680	676

## Tool kit timing crankshaft and camshaft of the new engines Renault 2.0 dCi



- Models: Renault Megane, Scenic, Laguna, Vel satis, Espace, Koleos, Trafic.
- Engine: 2.0 dCi (chain).
- Engine codes: 700, 722, 724, 740, 742, 446, 760, 76, 780, 802, 803, 805, 830, 832, 833.
- Models: Nissan Qashqai, X-Trail, primastar
- Engine: 2.0 dCi (chain)
- Engine codes: M9R 780, 830, 832, 833 this kit is also suitable for engines Vauxhall / Opel
- Aggioranta new version which includes the key lock flywheel and crankshaft pulley.
- With instructions included.

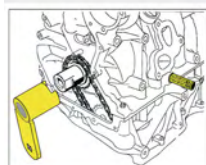

Code	Desc.
4770005690	678

## Tool for the commissioning phase of the pulley camshaft engine Renault petrol



- Models: Clio III, Modus, Scenic II, Grand Scenic II, Laguna II, Kangoo
- Engines: 1.4 & 1.6 16 v.
- Engine codes: K4M - 708/716/730/732/750/752/753/760/761/766/782/800/801/812/813.

Code	Desc.
4770002980	298



## Locking bracket for new Renault gasoline engines



- The bracket is already present in the kit Renault Article 477 00 and 477 00 05 680 05675.

Code	Desc.
4770005685	677

## Locking Plate camshaft sprocket for Renault engines 1.8 & 2.0 t 16 v



- Models: Clio II, Megane, Megane II Megane / Scenic, Scenic / RX4, Scenic / Grand Scenic II, Laguna, Laguna II, Espace / Grand Espace, Espace / Grand Space IV, Traffic II.
- Engine: 1.8 16v & 16v 2.0 t.
- Codes: F4P 720/722/760 F4R 700/701/712/713/714/715/720/722/730/732/740/741/744/746/770/771/776/780/784/786/787 / 790/791/792/794/795 / 796/797/820/830.

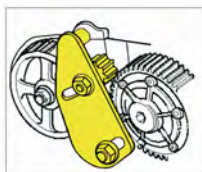

Code	Desc.
4770005720	684

8

## Kit timing engines VW-Audi-Seat-Skoda 1.4 & 1.6 16v. gasoline



- Models: Audi A2 Seat Arosa, Ibiza, Cordoba, Inca, Leon, Toledo Skoda: Fabia, Octavia VW: Lupo, Polo, Beetle, Golf, Bora, Caddy
- Engines: 1.4 & 1.6 16V. SHAFT
- Engine codes: AFH, AFK, AHW, AJV, AKQ, APE, AQQ, ARC, ARR, ATN, AUA, AUB, AUS, AVY, AXP, AZD, BAD, BBY, BBZ, BCA, BCB, BKY.
- With instructions included.

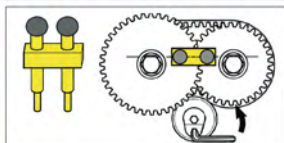

Code	Desc.
4770002740	274

## Kit complete with tools for timing engines VAG Diesel

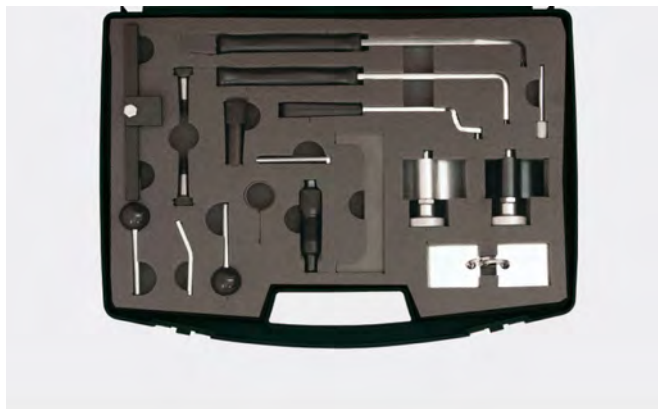

- Models: Audi: 80, A2, A3, A3 Cabrio, A4, A4 Quattro, A5, A5 Coupe / Cabriolet, A6, Quattro A6, TT, Q5 Seat Ibiza, Altea, Altea XL, Arosa, Ibiza / Cordoba, Inca, Leon, Toledo, Aahambra Skoda: Exeo, Fabia, Fabia II, Felicia, Roomster, Octavia, Octavia Tour, Octavia II, Superb, Superb II VW: Lupo, Polo, Polo / Classic, Fox, Golf / Bora, Golf / Plus, Jetta, Jetta III, Eos, Beetle, New Beetle, Scirocco, Tiguan, Passat, Passat CC, Touran, Sharan, Caddy, Wind, Caddy Maxi, Golf Estate, Sharan, Transpoter.
- Engine: 1.2TDI PD, 1.4TDI PD, 1.7SDI, 1.9D / TURBO, 1.9SDI, 1.9TDI, 1.9TDI PD, PD 2.0TDI, 1.6TDI CR, 2.0TDI CR
- Codoci engines: AJM, AMF, ANU, ANY, ARL, ASZ, ATD, ATJ, ATL, AUY, AVB, AVF, AVQ, AWX, AXB, AXC, AXR, AYZ, AZV, BAY, BDK, BGW, BHC, BHP, BHW, BJB, BKC, BKD, BKE, BKP, BLS, BLT, BMA, BMN, BMR, BMS, BMT, BNM, BNV, BPX, BRB, BRM, BRR, BRS, BRU, BSU, BSV, BSW, BTB, BUK, BUY, BUZ, BVA, BVE, BVF, BVG, BVK, BWB, BWV, BX, BXF, AZV, BDJ, BHP, BKD, BLB, BMA, BMM, BMN, BMP, BMR, BNA, BPW, BRC, BRE, BRF, BRT, BSS, BUY, BUZ, BVA, BVE, BVF, BVG, BVH, BWV, CAYA, CAYB, CAYC, CagA, CAGB, CAGC, CAHA, CAHB, CBAA, CBAB, CBAC, CBBA, CBBB, CBDA, CBDB, CBDC, CBEA, CEGA, AHB, AHG, AKU, AKW, 1X, 1Y, AAZ, ABL, AEF, AEY, AGD, AGP, AQM, ASX, ASY, AYQ, 1Z, AFF, AFN, AGR AHF, AHH, AHU, ALE, ALH, ASV, AVG.
- With instructions included.

Code	Desc.
4770005705	681

## Complete kit for timing engines Petrol VW 1.4, 1.4 FSI, 1.6, 1.6 FSi, 1.8, 1.8T, 2.0, 2.0 16v., 2.0 FSi / TFSi (belt)

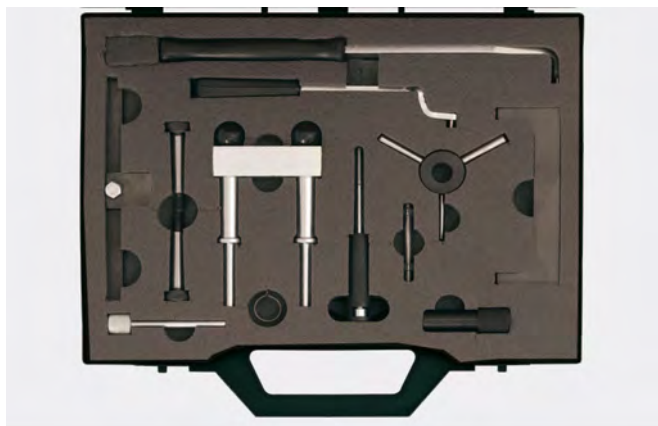

- Models: Audi: 80, A2, A3, S3, A4, A6, Audi TT: 80, A2, A3, S3, A4, A6, TT Seat Altea / XL, Arosa, Ibiza, Cordoba, Inca, Leon, Toledo, Aalhambra Skoda: Fabia, Octavia, Octavia II, Superb VW Polo, Polo / Classic, Beetle, Caddy, Lupo, Golf / Golf Estate, Golf Plus, Bora, Passat, Vento, Jetta, Eos, Touran, Sharan, Transpoter.
- Engines: 1.4 & 1.6 16V. SHAFT, 1.4 FSI, 1.6, 1.6 FSI, 1.8, 1.8 16V, 1.8 T, 2.0 16V, 2.0 FSI / TFSI (belt)
- Codes: AFH, AFK, AHW, AJV, AKQ, APE, AQQ, ARC, ARR, ATN, AUA, AUB, AUS, AVY, AXP, AZD, BAD, BBY, BBZ, BCA, BCB, BKY, April, ADR, AEB, AFY, AGN, AGU, AJH, AJL, AJP, AJQ, AMK, AMU, ANB, APG, APH, APP, APT, APU, APX, APY, AQA, AQX, ARG, ARX, ARY, ARZ, ATC, ATW, AUM, AUQ, AVC, AWC, AWP, AWU, AWV, AYP, BAM, BEA, BFV, BKF, BNU, BVP, BVR, 1F, ABM, ADA, ADP, AEH, AEK, AFT, AHL, AKL, AKS, ALZ, ANA, APF, ARM, AUR, AVU, AYD, BFQ, BFS, BFQ, BGU, BSE, BSF, ABS, ADR, ADZ, AGN, AJP, AMU, APG, APT, APX, ARG, AVV, BFV, BVP, BVR, AGU, AJH, AJL, AJQ, AMK, ANB, APP, APU, APY, AQA, AQX, ARX, ARY, ARZ, AUM, AUQ, AVC, AWC, AWT, AWU, AYP, BAM, ADL, 2E, AAC, AAE, ABK, ABT, ACE, ADY, AEG, AGG, AKT, APK, AQY, ATM, ATU, AWF, AWG, AXA, AZG, AZH, AZJ, AZL, AZM, BEH, ABF, AXW, BGB, BHD, BMB, BPJ, BPY, AXW, BLY, BLR, BVX, BVY, BVZ, AXX, BWA.
- With instructions included.

Code	Desc.
4770005710	682

## Kit commissioning phase motors VW 1.2 L, 3 cil.9v 12v gasoline

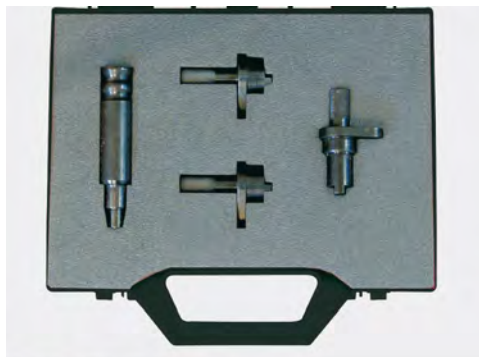

- Models: Volkswagen Fox, Lupo, Polo, Skoda: Fabia Seat Ibiza, Cordoba
- Engines: 1.2 DC 9V-12V 3 cyl.
- Engine codes: AWY, AZQ (55-64 hp) BME.

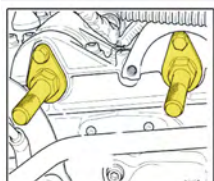

Code	Desc.
4770004680	328

## Kit timing engines VW-Audi-Seat-Skoda 1.2, 1.4, 1.6, 1.9, 2.0 Diesel

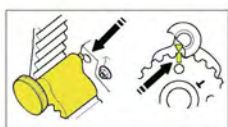

- Included: tool, lock crankshaft pulley round engines TD
- Models: Audi A2, A3, A3 Cabrio, A4, A4 Quattro, A5 Coupe / Cabriolet, A6, A6 Quattro, Q5, TT Seat: Alhambra, Altea, Altea XL, Arosa, Cordoba, Ibiza, Leon, Toledo, Skoda: Exeo, Fabia, Fabia II, Octavia, Octavia Tour, Octavia II, Roomster, Superb, Superb II Volkswagen Beetle, Bora, Caddy, Caddy Maxi, Eos, Fox, Gofl, Golf Plus, Golf Estate, Jetta, Jetta III, Wolf, Passat CC, Polo, Scirocco, Sharan, Tiguan, Touran, Transporter Ford: Ggalaxy
- Engine: 1.2 TDI PD, 1.4 TDI PD, 1.6 TDI CR, 1.9 TDI PD, 2.0 TDI PD, 2.0 TDI CR
- Engine codes: AJM, AMF, ANU, ANY, ARL, ASZ, ATD, ATJ, ATL, AUY, AVB, AVF, AVQ, AWX, AXB, AXC, AXR, AYZ, AZV, BAY, BDK, BGW, BHC, BHP, BHW, BJB, BKC, BKD, BKE, BKP, BLS, BLT, BMA, BMN, BMR, BMS, BMT, BNM, BNV, BPX, BRB, BRM, BRR, BRS, BRU, BSU, BSV, BSW, BTB, BUK, BUY, BUZ, BVA, BVE, BVF, BVG, BVK, BWB, BWV, BX, BXF, CagA, CAGB, CAGC, CAHA, CAYA, CAYB, CAYC, CBAA, CBAB, CBAC, CBBA, CBBB, CBDA, CBDB, CBDC, CBEA, CEGA.

- Little hand notched left.
- With instructions included.

Code	Desc.
4770005695	679

## Kit timing engines VW-Audi-Seat-Skoda 2.0 TDi PD



- Included: tool, lock crankshaft pulley oval motor BDJ, BLB, BMM, BMP, BNA, BPW, BRC, BRE, BRF, BRT, BSS, BVH.
- Models: Audi A3, A4, A4 Cabrio, A4 Quattro, A6 Seat: Alhambra, Altea / Altea XL, Leon, Toledo, Skoda Octavia, Octavia II, Superb, Superb II Volkswagen Bora, Caddy, Caddy Maxi, Eos, Golf, Golf Estate, Golf Plus, Jetta, Passat, New Beetle, Sharan, Touran, Transporter Ford Galaxy.
- Engine: 2.0 TDi PD
- Engine codes: AZV, BDJ, BHP, BKD, BLB, BMA, BMM, BMN, BMP, BMR, BNA, BPW, BRC, BRE, BRF, BRT, BSS, BUY, BUZ, BVA, BVE, BVF, BVG, BVH, BWV.
- Little hand notched DX.
- With instructions included.

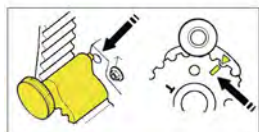

Code	Desc.
4770004720	332

## Kit timing engines VW, Audi, Skoda, gasoline



- Models: Volkswagen Polo, Golf, Golf Plus, Touran, Passat Audi A3 Skoda Octavia
- Engines: 1.4 & 1.6 fsi (chain)
- Engine codes: AXU, BAG, BKG, BLF, BLN, BLP.
- With instructions included.

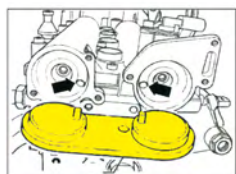

Code	Desc.
4770005700	680

## Key tensioner with long handle for petrol and diesel engines fitted to VW, Audi, Seat, Skoda



Code	Desc.
4770002771	277L

## Key tensioner with short handle for petrol and diesel engines fitted to VW, Audi, Seat, Skoda



Code	Desc.
4770002770	277C

## Key tensioner for gasoline and diesel Volkswagen, Audi, Seat, Skoda



Code	Desc.
4770005715	683